



Research Report 2018/19

International Graduate School
for Dynamics in Logistics



Bremer Logistik Transfer-
und Innovationskultur

Content

Dynamics in Logistics	2
Bremen Logistics Transfer and Innovation Culture	8
International Doctoral Training in Logistics	14
Achievements and Guests of the IGS	18
Marcella Bernardo	
Robust Solution Approach for the Stochastic Vehicle Routing Problem	21
Marco Cen	
Surface Functionalization of Polyimide Substrates for Microsensors' Applications	25
Haniyeh Dastyar	
Simulation-based Optimization in Supplier Development	27
Supara Grudpan	
Challenges with Technologies for Collaboration in Urban Logistics	31
Zhangyuan He	
Sustainable Inner-Urban Intermodal Transportation in Retail/Post	33
Gabriel Icarte	
A Multi-agent System for Truck Dispatching in an Open-pit Mine	35
Wacharawan Intayoad	
Exploring Contextual Information in Manufacturing and Logistics Processes	39
Ayesha Khan	
The Role of Transportation Infrastructure in China-Pakistan Economic Corridor	43
Vishnu Priya Kuppusamy Parimalam	
Evaluating Forwarding Protocols in OppNets: Trends, Advances and Challenges	47
Ping Liu	
Operator-based Decentralized Capacity Control of Job-Shop Systems with RMTs	49
Himangshu Sarma	
Virtual Movement from Textual Instructions	53
Sayed Mehdi Shah	
Monitoring External Supply Chain Risks in Apparel Sourcing through Text Mining	55
Feroz Siddiky	
Human Activity Video to Virtual Reality Execution	57
Jing Ye	
Alternative Distribution Channels Provided by BRI	59
Ambreen Zaman	
A Shoe for Surgeons to Interact with Radiological Images	61
Qiang Zhang	
Combining Predictive Control with Integer Operators for Capacity Adjustment with RMTs	65
References to Previous Publications	67
Imprint	68



Dynamics in Logistics

Dear Reader,

Logistics has significantly influenced the development of the world in its present form. It has driven social, economic, and technological change and continues to inspire it. Each of us is aware of it and uses its added value. The development of logistics enables us to use the desired products and services at the right time, in the right quality and at the place of our choice. Digitalization, in particular, has led to significant leaps in development and new logistics services in recent years.

In Bremen, logistics is socially and economically indispensable. The history, the firmly networked logistics centers, and the locational advantages show the outstanding importance. Bremen's proximity to the sea makes it an essential location for maritime logistics. Production facilities, logistics areas, the excellent infrastructure, the geographical location, and the logistical competence on short distances characterize Bremen as a logistics location.

Research and teaching are the basis for the further expansion of Bremen's success story. For almost 25 years, an interdisciplinary team from various departments of the University of Bremen and local institutions in the Bremen Research Cluster for Dynamics in Logistics (*LogDynamics*) has been researching the logistics of tomorrow and beyond. The precursors of the Internet of Things were already developed in *LogDynamics* around the turn of the millennium.

Concerning the strategies of the University of Bremen and the State of Bremen, the Research Alliance covers the challenges of the future for Bremen and consistently transfers its science into society.

In the future, digitization and artificial intelligence will significantly change logistics. People will become more and more the focus of attention and increasingly demand individual logistics solutions. Besides, climate and energy will have an ever-greater influence. The diversity-oriented International Graduate School for Dynamics in Logistics (IGS) of *LogDynamics* deals precisely with these topics and prepares doctoral students for the upcoming changes. As a sustainable result, several international connections have been established and are still alive.

The transfer of scientific findings from science into society, business, politics, culture, and vice versa is another crucial task for the future. Since 2018, the BreLogIK project (Bremen Logistics Transfer and Innovation Culture) has underscored this theme by working with several local actors beyond *LogDynamics*. The initiative focuses on removing barriers in the cooperation between science and industry to create a novel infrastructure for innovations in logistics.

I wish you many new insights as you read this report. We are still committed to making logistics in Bremen future-proof.



Dr.-Ing. Matthias Burwinkel
*Managing Director of LogDynamics
 LAB and Project Coordinator of
 BreLogIK*



Logistics in Bremen

The federal state of Bremen is the second largest logistics location in Germany. This is due to its advantageous maritime position and good hinterland network. Established logistic-related companies are based in Bremen, for example aeronautics and space technology, automobile construction, food manufacturers, etc. The importance of the logistics industry for the state of Bremen implies the respective scientific focus.

The University of Bremen meets the demand for logistics research by linking competences of different scientific disciplines within an interdisciplinary high-profile area. Therefore, *LogDynamics* was founded in 1995 as a cooperating network of research groups originated from four faculties: Physics/Electrical Engineering, Mathematics/Computer Science, Production Engineering and Business Studies/Economics. Besides the research groups, further partners within *LogDynamics* are: BIBA – Bremer Institut für Produktion und Logistik GmbH, ISL – The Institute of Shipping Economics and Logistics (ISL), and the Jacobs University Bremen gGmbH.

The activity fields of *LogDynamics* range from fundamental and applied research to transferring findings into practice. The research cluster collaborates closely with enterprises enabling a bidirectional transfer of knowledge and technology between business and academia. The objective is to strengthen research and development in the competence areas of logistics for the benefit of the region Bremen as well as to foster international cooperation.

Interdisciplinary Cooperation

The logistics challenges cannot be solved within one single scientific discipline. Therefore, the research is based on interdisciplinary cooperation to generate synergy effects. The competencies and interests of the involved research groups will be introduced in the next chapter. *LogDynamics* conducts fundamental and applied research, offers education at the highest level and organizes scientific conferences. At the same time the reference to industrial practice is one of the most important aspects. *LogDynamics* makes special efforts to feature opportunities for cooperation between science and industry. Further-

more, it promotes the idea of giving small and medium-sized enterprises access to research and innovation. The resulting dialogue of industry and science contributes to a better understanding of the different perspectives and possible solutions in logistics.

Infrastructures for Research, Education and Transfer

The **Demonstration and Application Centre for Dynamics in Logistics (*LogDynamics Lab*)** is a platform for researchers and industry to develop and explore advanced technologies for real-world problems in logistics:

- Mobile technologies, smart products, Internet of Things and their use in dynamic and complex logistics networks.
- Agile product development and Rapid Prototyping for low-risk and low-cost feasibility testing of new technologies
- Optimization of processes by means of eliminating waste by using analogue and digital lean approaches
- Open Innovation Methods in logistics processes



Research Beyond Boundaries

The bi-annual **International Conference on Dynamics in Logistics (LDIC)** is a scientific exchange forum. It provides new approaches to dynamic aspects of logistics and brings together top-class researchers from all over the world. The spectrum of LDIC topics ranges from modelling, planning and control of processes, supply chain management and maritime logistics to innovative technologies and robotic applications for cyber-physical production and logistics system.

A Doctoral Workshop at LDIC and the **LogDynamics Summer School (LOGISS)** strive to generate an extended network of young researchers beyond *LogDynamics*. The aim is to foster ideas from other disciplines and give rise to opportunities for joint research. To support this process, both measures offer intensive tutorial lectures delivered by international experts from renowned universities as well as hold group lab sessions, accompanied by social events such as get-together, dinner and guided tours.

The **International Graduate School for Dynamics in Logistics (IGS)** is the structured doctoral training program of *LogDynamics*. It offers outstanding researchers from all around the world the opportunity to complete a doctorate at a logistics location of long standing tradition. The objective of the IGS is to foster excellence in research and education by pursuing an interdisciplinary and cross-cultural approach. Furthermore, it combines the best of the German individual doctoral studies with selected elements of structured Ph.D. programs.

Research groups of four faculties of the University of Bremen are members of

LogDynamics. That includes the professors, who are the heads of the research groups, as well as some of their post-doc researchers and research assistants.

Faculty 1: Physics / Electrical and Information Engineering

Dynamics in Logistics is intrinsically tied to the information exchange between all the players in the logistics domain, such as suppliers, manufacturers, transport companies, customs, and authorities. This information exchange is based on an increasing number of fixed and wireless information networks. Access networks usually employ wireless or mobile network technology, which are connected to infrastructure networks either directly or indirectly. These networks range from sensor networks to satellite networks. Research topics in this area are related to the performance evaluation and optimization of communication processes. Another related aspect investigated is the use of information networks to implement dynamic routing algorithms for transport logistics. These react to the dynamic events that, sometimes drastically, influence transport processes. Head of the research group for Communication Networks is **Prof. Dr. Anna Förster**.

In the near future, it will be possible to capture not only the position of each container world-wide, but also of any pallet or even each individual piece of goods. The conditions of carriage like temperature or humidity have to be supervised permanently and influence current decisions. Due to the high amount of resulting data, centralized control will not be possible. Especially during periods of missing radio communication, when the freight has to

react on disturbances and new information correctly. With new mathematical theories and progresses in the fields of microelectronics and micro system technologies, it will be possible to integrate low-cost sensors to monitor and control the product quality as well as the environmental parameters. This contains the conception of the ad-hoc sensor network and the corresponding communication system. New sensors and wireless communication mechanisms have been investigated under the notion of "Intelligent Container". **Prof. Dr.-Ing. Walter Lang** is the director of the Institute for Microsensors, -actuators and -systems (IMSAS).

Faculty 3: Mathematics / Computer Science

In the logistics' futuristic scenarios, intelligent autonomous robots will automate warehouses and logistics centers by fetching, placing, and rearranging products. Furthermore, they will automate the supply chains for the production and transportation of goods. **Prof. Michael Beetz Ph.D.** is head of the Institute for Artificial Intelligence. His research interests include plan-based control of robotic agents, knowledge processing and representation for robots, integrated robot learning, and cognitive perception.

Circuits and systems were mainly applied in computers a few years ago. Meanwhile, they are part of everyday life and are used more and more in safety-critical areas. They are the core technology in Cyber-Physical Systems (CPS). CPS play a key role in overcoming logistical challenges, and they contribute to finding solutions for the increasing complexity in the logistic

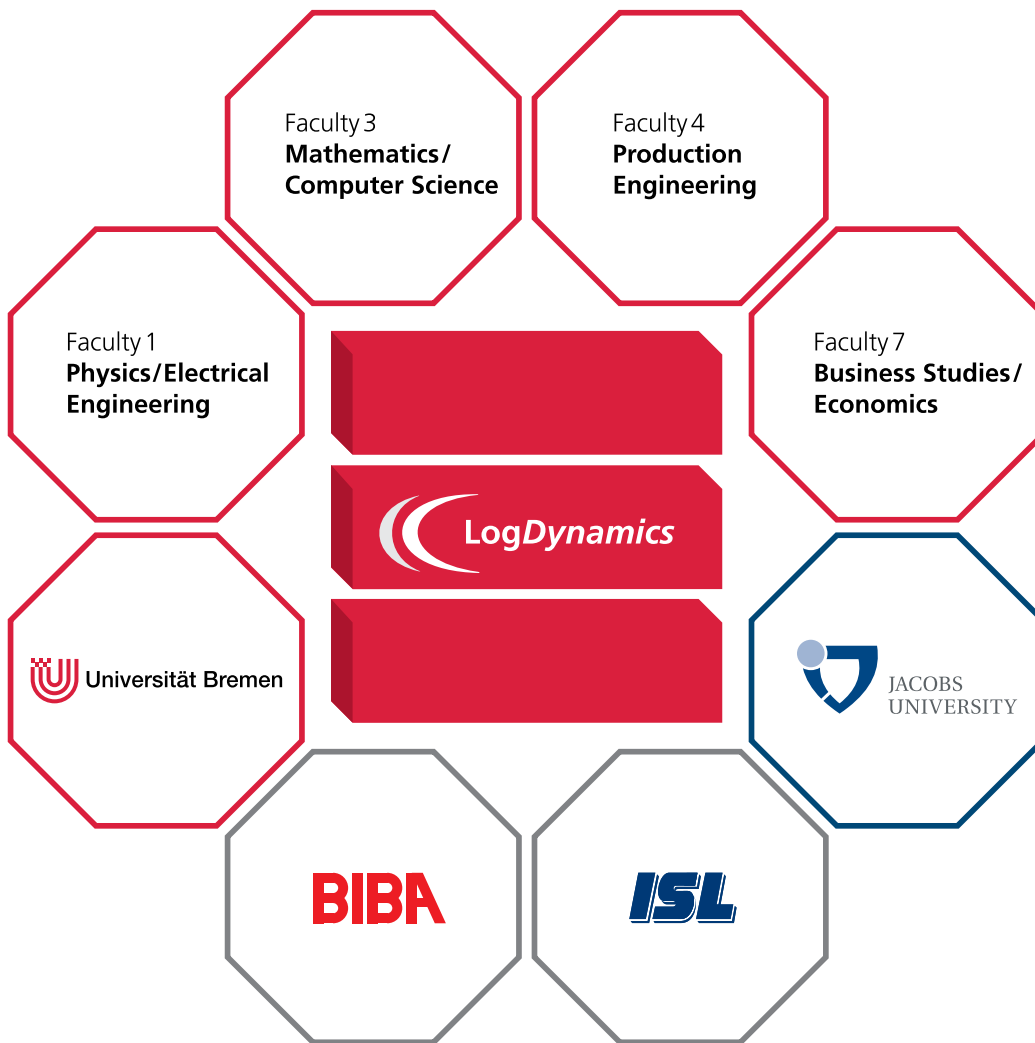

sector. **Prof. Dr. Rolf Drechsler** represents the subject of computer architecture in research and teaching. His research interests comprise of the complete design flow of circuit and system, where he focuses particularly on testing and verification using formal techniques. Since 2011, he is a director in the German Research Center for Artificial Intelligence (DFKI) in Bremen, where he also leads the research group of Cyber-Physical Systems.

In analogy to conventional logistics, autonomous logistic processes are in need of knowledge to perform their task. Data, information, and knowledge are the key resources, which ensure the quality of a logistic process. Knowledge management is required to support autonomous logistic processes by providing context-sensitive information. In addition, it has to be considered that actors in these processes act in a competitive way. Consequently, information and knowledge should be treated as tradable goods, which hold high utility potential for their consumers. Projects by

Prof. Dr.-Ing. Otthein Herzog include, for example, knowledge management for the planning and scheduling of autonomous logistic processes.

In software engineering, as well as in other areas of computer science, diagrams and graphs are used in manifold ways for modelling logistic processes, easily describing and visualizing complex structures. Rule-based methods have proven to be extremely effective for capturing dynamic aspects like process and system flow. This inspires the attempt to employ rule-based graph transformation of modelling logistic processes and systems. Since the so-called graph transformation units, in particular, include a control component, they are an obvious choice for the description of autonomous logistic processes. **Prof. Dr.-Ing. Hans-Jörg Kreowski** is a professor for theoretical computer science and a member of the Technology Centre Computer Sciences and Computer Technology (TZI).

IT is taking over all living and work environments while it has not previously

been capable of providing support to the people on the move. **Prof. Dr. Michael Lawo** is a professor for applied computer science and is also involved in numerous projects of logistics, wearable computing, artificial intelligence and IT-security. In his research, he deals mainly with human-computer-interaction for industrial as healthcare applications, or even human-robot-collaboration.

Logistic processes are always linked to the humans who can play multiple roles. Humans are at the one end of the process: customers or consumers. At the other end, they manage and control processes, and in the middle they can work as drivers, packers or in a variety of different roles. Modelling the semantics of logistic processes and interaction in and with logistic processes is an important subject in logistics and human computer interaction. **Prof. Dr. Rainer Malaka** is a professor for Digital Media and the director of the TZI (Centre for Computing and Communication Technologies). The focus of his work is intelligent-interactive

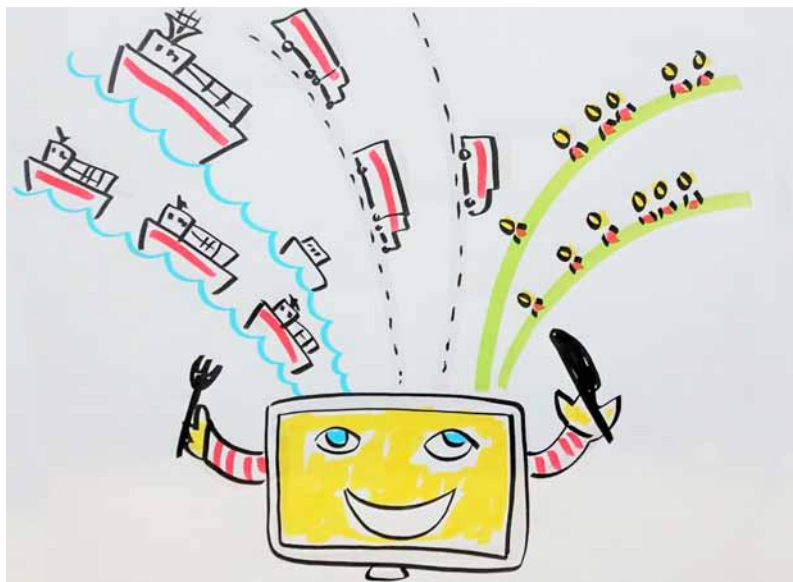

Synergies by Inter- disciplinarity

systems and his projects include interactive systems, contextual computing, multimodal interaction, semantics and ontologies, adaptive and cognitive systems.

Prof. Dr. Nicole Megow is professor of computer science methods for adaptive control in production and logistics at the University of Bremen. Her main research interests are in the field of combinatorial optimization, on the design and analysis of efficient algorithms with provable performance guarantees. She and her group contribute with theoretic results and apply them to complex real-world environments, e.g. in production planning and logistics.

Faculty 4: Production Engineering

The goal of the Production Systems and Logistic Systems group, administered by **Prof. Dr. Till Becker**, is the development of novel approaches for the design of robust and efficient manufacturing and logistics systems. Its research focuses on the understanding of the interrelations between the material flow as the dynamical component and the structure as the topological component of a complex logistic network. This includes the analysis of the impact of disturbances and fluctuations, the design of robust manufacturing systems, and the design of interfaces between local manufacturing systems and global logistic structures.

Industry 4.0 technologies, particularly cyber-physical production and logistics systems, and new opportunities for robot-supported automation of logistic processes are strong forces behind the changes in production and logistics systems. Intensive global competition, as well as changing and diverse customer requirements boost

the necessity for using these technologies, while at the same time developing adaptive, flexible and dynamic production and logistics systems. However, these systems can only unfold their full capacity if their planning and control are more decentralized and dynamic. Based on this background, the research unit Intelligent Production and Logistics Systems sees its major tasks in the research, development and application of Industry 4.0 technologies for production and logistics, the automation of logistic processes with the help of these innovative technologies, and in the development of efficient and practice-suited planning and control methods for production and logistics. **Prof. Dr.-Ing. Michael Freitag** administers this research unit and is the director of BIBA – Bremer Institut für Produktion und Logistik GmbH.

The dynamics of logistic networks and processes is growing in today's globalized world. This implies new technical and structural challenges to design and steer such systems. **Prof. Dr. Jürgen Pannek** is a professor for Dynamics in Logistics, a subject which combines engineering science, informatics, mathematics and the science of management. His research focus lies on the development of methods for modelling, simulation and control of logistic systems regarding dynamics and complexity on the operational, tactical and strategic levels. Instead of compensating for the dynamics, his goal is to integrate and utilize it within the control of the production and logistic system.

High performing co-operations between independent companies with the aim to develop and realize customized products are an important success factor

for the competitiveness of the European industry. So-called enterprise networks can be seen as an addition to the traditional supply chains. The research unit "ICT applications for production" prepares, develops, and discovers methods and tools to support co-operative inter-organizational enterprise networks. The research concentrates on the efficient and effective collaborative design and production processes by applying innovative information and communication technologies (ICT). The focus is the collaborative acting of enterprises during distributed design and production processes, and during the late processes of the product life cycle such as the usage phase or the recycling phase. **Prof. Dr.-Ing. Klaus-Dieter Thoben** is the director of this research unit. He is also the managing director of BIBA – Bremer Institut für Produktion und Logistik GmbH and spokesman of LogDynamics.

Faculty 7: Business Studies and Economics

Business logistics research in cargo mobility and elaboration of management tools, which are elaborated for the development and techno-economic evaluation of an added value orientated system integration of multimodal transport already pick up today's major design options for the realization of sustainable logistics. **Prof. Dr. Dr. h.c. Hans-Dietrich Haasis** is an industrial engineer and holds the chair in maritime business and logistics. He is the spokesman of the IGS, as well as an official member of the Board of Academic Advisers to the Federal Minister of Transport and Digital Infrastructure. Applied research, education, training and knowledge transfer

of the chair focus on cooperative techno-economic solutions in logistics, on maritime transportation and on decentralized production, as well as on business logistics concepts and on process management innovations for enterprises and regions. These topics also integrate an e-business orientated management of supply chains, the design and evaluation of smart logistics processes, as well as concepts for digitalization of business logistics.

Global value chains are changing the fabric of business logistics for firms. They demand strategy setting from the point of view of logistics operations, supplemented with the active management of international logistics flows and processes for value creation. Advances in managerial approaches, decision support tools, informational and physical technologies may aid in this effort, just as new logistics structures, strategies and configurations need to be considered in terms of their value creation potential, and call for further exploration. **Prof. Dr. Aseem Kinra** focus on value, barriers and complexity in cross-border value chains, especially in relation to logistics and transportation systems. Projects include the applicability and adoption of various information and transportation technologies such as blockchain, big data and predictive analytics for risk and performance management, both within private and public-sector supply chain management.

General Business and Logistic Management is the domain of **Prof. Dr. Herbert Kotzab**. He understands it as an inter-organizational relationship management that aims at improving logistic profitability of all involved actors in a logistics system. The theoretical foundation is based on the basic ideas of transaction cost theory, network theory, and the resource-based view. In addition, the cross-sectorial character of logistics also allows the consideration of interface problems, in particular in the areas of marketing, production and the technology management, but also the networking with other disciplines, such as natural sciences, mathematics, and engineering sciences. The main activities of Prof. Dr. Herbert Kotzab working group are the development, evaluation and communication of innovative technical-economic design and control measures in business administration, logistics, transport and distributed production. Quantitative and qualitative assessment and decision-making instruments are also developed.

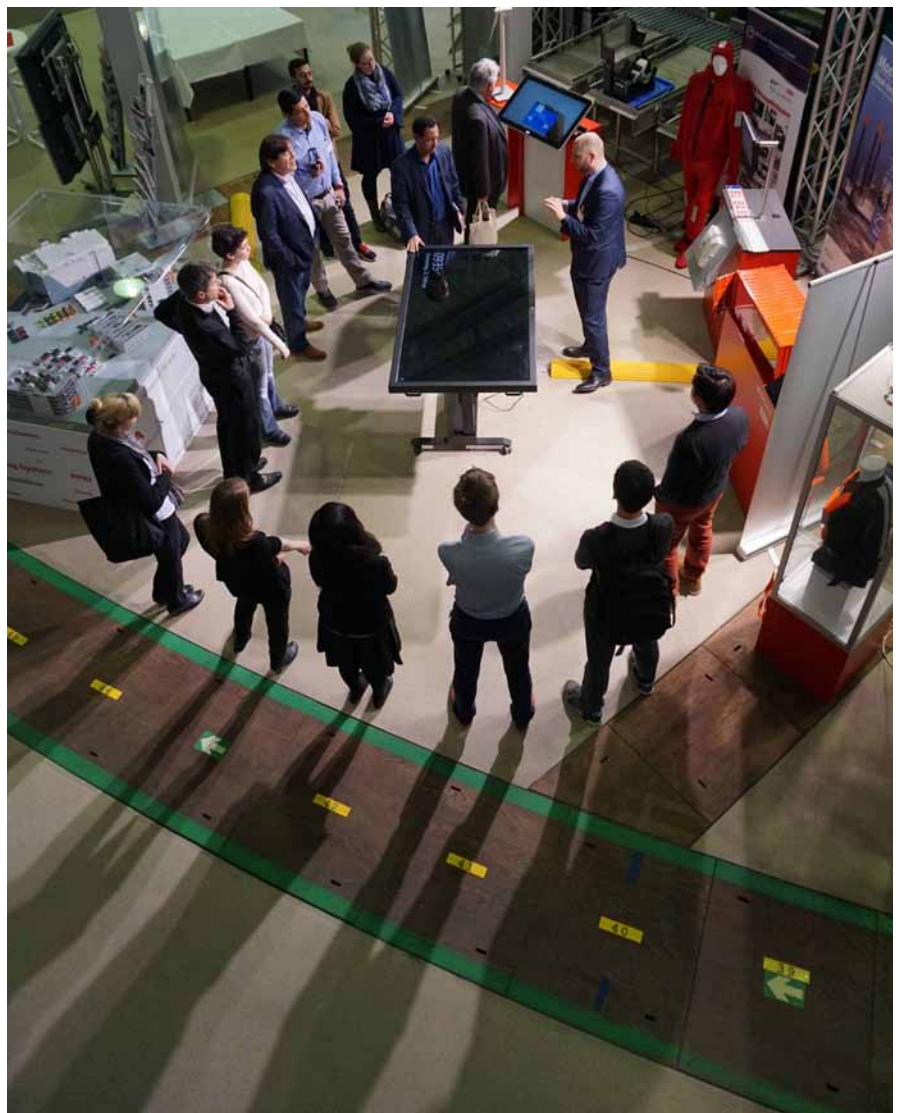

Brelogik

Bremer Logistik Transfer- und Innovationskultur

The logistics industry is undisputedly one of the most important driving forces for the Bremen economy. In addition to traditional transport service providers, the Hanseatic city is home to a large number of logistics-intensive industrial and commercial enterprises, consulting firms and scientific institutes as well as training and further education facilities. Many of these are characterized by small and medium-sized companies (SMEs). Aligning the organization to innovation poses significant challenges for SMEs that they often cannot serve. Even if potentials are known, companies cannot provide the necessary infrastructures and corresponding clout to exploit these potentials independently. The most common argument is the “time factor” that would have to be applied to innovation projects and much more to innovation co-operation. Other barriers are daily business and the fact that these companies are service providers without an own product. In principle, it is understandable that the fast-paced business (here in logistics) strongly ties operational forces and operational management in day-to-day business. However, the special framework conditions in companies from non-research intensive sectors, such as logistics, which are characterized by process innovation vs. product innovation, high dependency on a few clients or high competitive pressure and substitution offers, require the testing and evaluation of a promising mix on innovation instruments that may already have been tested for research-intensive companies. Especially process innovation like elimination of waste within the value chain or CO₂ neutral processes will be relevant in the future. The major task for logistic com-

panies is the creation of valuable business processes integrating the three essential challenges “digitalization”, “climate” and “energy”.

The project **Bremen Logistics Transfer and Innovation Culture (BreLogIK)** aims to address and exploit previously unused opportunities in close cooperation between Bremen’s science and logistics industry. On the one hand, it necessary to articulate the demands in the ongoing dialogue between business and science. On the other hand, opportunities for transfer must be identified. To increase the quantity and quality of transfer activities, BreLogIK starts with the following working hypotheses:

- Supporting the industry with low-threshold contact-based offerings and the systematic processing of inquiries and requirements increase the potential of further transfer-oriented follow-up activities with the corresponding acts
- Awareness-raising through low-threshold access to problems and challenges of the economy improves the quality of the transfer
- An approach and tools adapted to the needs of the users allow for adapting measures and tools to regional and industry-specific features
- Meeting spaces between science and industry increase goal-oriented, efficient dialogue
- Transparent information on needs and offers as a crucial content-based basis for the transfer can be supported by platforms, scouting activities, workshops, and small projects

The success of BreLogIK is thus not only dependent on the cooperation of Bremen’s research institutions but only with the help of a targeted dialogue with logistics companies and associations. The project creates a field of experiments for innovations and aims to strengthen the transfer between science and industry in both directions. Universities and research institutes in logistics should improve their positions in the regional logistics industry as suitable partners for innovation. The success should also be visible in an overall growing project volume within this economy, including in terms of improving the innovation and transfer orientation in non-research-intensive sectors themselves. The objectives of the project are achieved through the following four interlinked work packages:

Professionalization of Innovation Management

There is still no comprehensive overview of all logistics players and their portfolios.



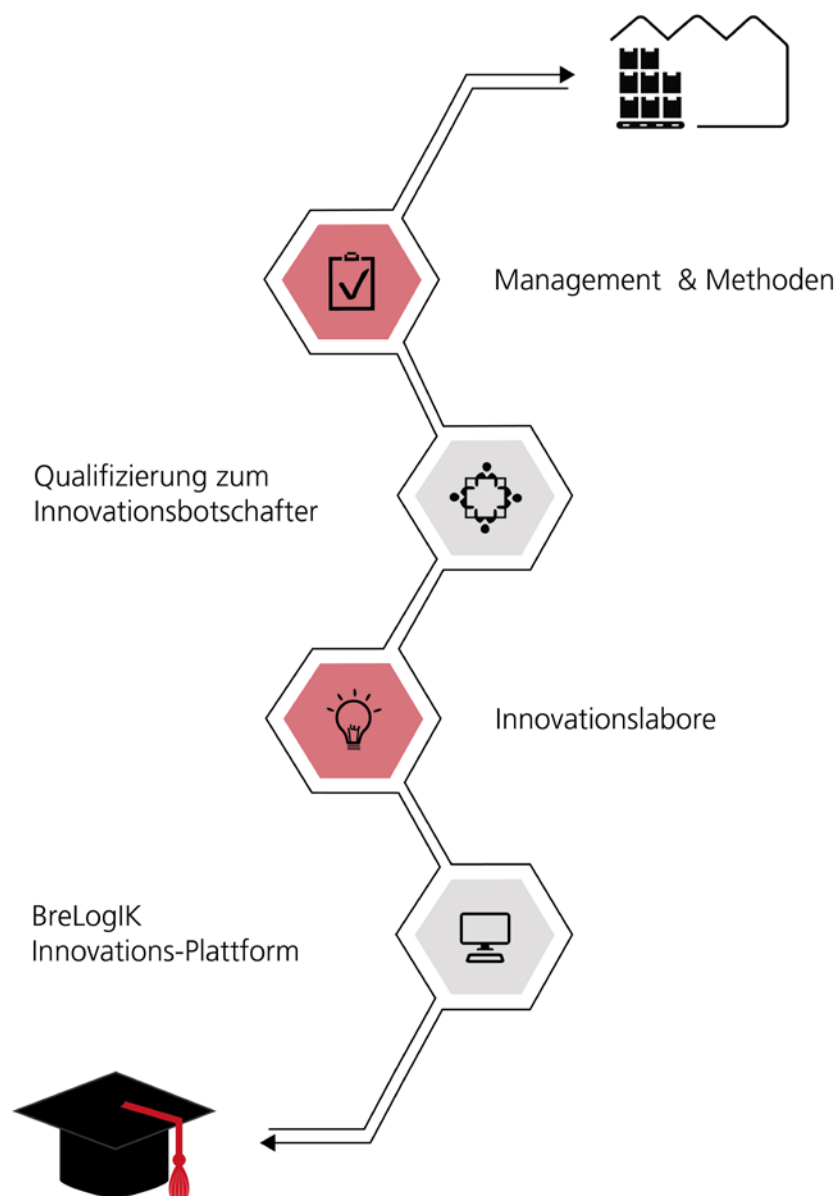

Therefore, a basis for further activities should be an actual analysis of the Bremen logistics industry. It should include as many actors as possible in the region and their portfolio. A second need is an overview of the innovation infrastructure of Bremen. There are various existing institutions like co-working space, incubators and accelerators. A transparent map for that is missing. Also it is necessary to examine the threshold of participation and to reduce it. Due to that suitable methods and new approaches for innovation management are developed.

Scientific Innovation Consulting

Scientists will be trained to become science ambassadors or scientific innovation advisors through a workshop series. Afterward, these consultants will identify the innovation needs of Bremen-based logistics SMEs and develop solutions through smaller “test

projects” (here, the methods newly learned in the workshop will be tested).

Innovation Labs

Existing innovation laboratories (such as the LogDynamics Lab) will be further opened up for Bremen-based logistics SMEs. Thus providing space for simulations or testing different approaches to innovation needs. A key success factor here is the open and barrier-free access to such innovation infrastructures. Besides, innovation workshops will take place in these laboratories to set new impulses for logistics players.

Innovation Platform

BreLogIK would like to create lasting added value for the Bremen logistics industry. Therefore, one aim is to implement an online database, which should remain valid even after the end of the project. Here, lo-

gistics players can define their individual need for innovation or a specific challenge and receive existing solution concepts by “matching”, current or already completed projects on the subject and possible co-operation partners for a new project. In the long term, science and industry will be synergized with each other.

The transfer concept is research-based and grounded on a coherent strategy for interaction with the regional economy. It starts from existing structures and experiences with the transfer of ideas, knowledge and technology. It creates structures and measures for improving the quality and quantity of transfers based on a regional potential analysis. It takes into account the currently known requirements to set up the transfer conversationally and recursively.



BreLogIK Partners

LogDynamics

The complexity of logistic networks and systems is growing in today's globalized world. Individual customers' requirements cause a significant number of product variants and services as well as shorter product life cycles. This implies new technical and economic challenges for logistic systems and processes. To meet these challenges, we need innovative logistics solutions that adapt flexibly to continuously changing conditions. The ability to control these dynamic aspects is essential for successful manufacturing and transport logistics.

Moreover, it guarantees strategic advantages in terms of competitiveness on the world market. Through research, knowledge transfer and convergence education in an international environment, LogDynamics contributes to new impulses and driving forces in the logistics sector in Bremen. These emergences and synergies will lead to strengthening the economy and dynamic regional development in Bremen.

BIBA – Bremer Institut für Produktion und Logistik GmbH

The BIBA is a research institute focussing on engineering science. It was founded in 1981 as one of the first affiliated institutes of the University of Bremen and counts as one of the largest research facilities in the federal state of Bremen. It consists of two divisions: "Intelligent Production and Logistics Systems", headed by Prof. Dr.-Ing. Michael Freitag and "ICT applications for Production", directed by Prof. Dr.-Ing. Klaus-Dieter Thoben. Based on distinct fundamental research, BIBA carries out applied and contract research, both on a national and international level, in the areas of pro-

duction and logistics for relevant industries like logistics, automotive, aviation and wind energy. BIBA has strong ties, in terms of both organization and content, with the departments of Planning and Control of Production and Logistics Systems and Integrated Product Development within the faculty for Production Engineering – Mechanical Engineering and Process Engineering at the University of Bremen.

BIBA participates in national and European research associations. It initiates a diverse range of projects at all levels. Behind such projects and research undertakings are around 150 BIBA employees from a variety of disciplines, whose specialisms span the areas of production engineering, industrial engineering and computer science as well as associated disciplines.

Global economic change presents a challenge to the fields of research and industry. Processes are becoming ever more complex and dynamic, and production and logistics are integrated into cooperative, global, inter-organizational networks. Consequently, dynamics and collaboration characterize not only the scientific content but also the research methods employed at BIBA. As part of this approach, the institute maintains a policy of intensive dialogue and transfer which incorporates both international corporations and small and medium-sized enterprises in the region.

ISL – Institute of Shipping Economics and Logistics

Thanks to the successful combination of tradition and modern science, the 1954 founded ISL is one of Europe's leading institutes for research, consulting and know-how transfer in maritime logistics. It offers

customers the development and integration of IT systems, market analysis and forecasts, funding consultancy as well as teaching and training in the following areas: Maritime Intelligence - Maritime Security - Maritime Environment - Maritime Transport Chains - Maritime Simulation. The employees are computer scientists, economists and industrial engineers, who form flexible interdisciplinary teams depending on the needs of the specific projects. The priority products and services are:

Contract Research and Consulting

ISL observes, analyses and forecasts maritime markets in all their facets based on extensive databases and models, which are also used for generating statistical publications. For such tasks, ISL applies its own North European Container Traffic Model and uses its tool CTS - Cargo Traffic Simulation. With this help, they can address both, global as well as regional issues, e.g. to analyze and forecast ports specific hinterland traffic including modal split and offer the corresponding consultancy.

Besides, ISL offers advice to companies and authorities on a multitude of issues concerning the maritime economic sector. Examples for clients are Federal and State ministries, the European Commission, port authorities, shipping companies and banks. The strength of ISL is the combination of know-how on economic and environmental issues, processes and information technology working in multi-disciplinary teams.

Databases and Regular Publications

- The ISL Port Data Base is unique worldwide and internationally recognized as a reliable, up-to-date source of infor-

mation. It contains structured and comparable information for roughly 400 maritime ports worldwide with long time series going back to the 1980s.

- ISL's North European Container Traffic Model (NECTM) is an integrated TEU-based model for the North range ports including deepsea and shortsea traffic as well as hinterland and transshipment regions for the ports of the Hamburg-Le Havre range (Le Havre, Zeebrugge, Antwerp, Rotterdam, Bremen/Bremerhaven, Hamburg) and for major Mediterranean and Baltic Sea ports.
- Each issue of the ISL Shipping Statistics and Market Review (SSMR) analyses a different market segment or aspect of seaborne traffic and trade. This English language publication comprises the sections Market Review, Statistical Topics and Market Comment.
- The ISL Monthly Container Port Monitor (MCPM) is the ideal tool for keeping track of the most recent container traffic developments. It allows ports and liner operators to benchmark their performance against the latest regional and global trends. The MCPM is based on approx. 83 major world container ports handling more than half of total world container traffic.

Hochschule Bremerhaven

The University of Applied Sciences (Hochschule) Bremerhaven was founded in 1975. Thanks to its predecessor institutions the Geestemünde Navigation College and the Municipal College, the education tradition of the Hochschule Bremerhaven can be traced back to more than a hundred years ago. Therefore, the Hochschule Bremerhaven distinguishes itself as the "university by the sea", not only because of its geographic location directly at the estuary of Weser, but mainly because of its 23 attractive study programs.

Currently, about 3,200 students are studying on the campus between the river Geeste and the pedestrian zone of the city of Bremerhaven. As shown in the result of university rankings over and over again, the study programs have a good reputation both nationally and internationally. Courses focus on engineering and economics. The university cooperates closely with the business. It is not only manifested by their close dialogue during the degree thesis and research cooperation. The Master's programs "Wind Energy" and "Integrated Safety and Security Management" are also impressive

evidence. Finally, funds for the establishment of the study programs come from regional companies which take the significance of the education into account and illustrate their connection with the university and its students in this way.

Logistics at Hochschule Bremerhaven

Globalization is ever-increasing, and outsourcing has become a trend. This means that goods flow into all directions, traffic is increasing, and the logistics sector is booming. Especially in Germany, a hub between east and west, between north and south, the industry of logistics has developed into one of the most substantial economic sectors. The demand for qualified specialists is growing every day and can hardly be covered in the foreseeable future.

The Hochschule Bremerhaven, as one of the training bases for experts in this field, is well recognized by European logistics companies. The tradition of the study program Transport / Logistics can be dated back more than 30 years. For years the study course has been awarded top rankings in logistics. Built upon decades of experience, the Master's program Logistics Engineering and Management qualifies the students for essential and sophisticated managerial tasks in international logistics. By using scientific methods, the students are capable of analyzing highly complex transport and transshipment processes, implement optimization measures, and to develop and apply new solutions. They can take on attractive managerial tasks in manufacturing, trade and service companies as well as incorporate consultancies.

Following the established tradition of the Hochschule Bremerhaven, the course of studies has its focus on technical logistics, economics, management, and law as well as information and communication technology. Thus, the students have access to the Bremerhaven-specific and multifaceted spectrum of knowledge, which has always been needed and still remains as a distinctive feature in the logistics employment market.

Dr.-Ing. Matthias Burwinkel

Wissenschaftlicher Mitarbeiter
Informations- und Kommunikationstechnische Anwendungen in der Produktion

Universität Bremen
c/o BIBA - Bremer Institut für Produktion und Logistik GmbH
Hochschulring 20
28359 Bremen / Germany

Phone: +49 (0)421 218 50140
Fax: +49 (0)421 218 50154
bur@biba.uni-bremen.de
www.BreLogIK.de

Andrea Voth

Wissenschaftsmarketing
ISL - Institut für Seeverkehrswirtschaft und Logistik

Universitätsallee 11-13
28359 Bremen / Germany

Phone: +49 (0)421 220 9631
Fax: +49 (0)421 220 9655
www.isl.org

Benjamin Küther

Wissenschaftlicher Mitarbeiter
Forschungs- und Technologietransfer

Hochschule Bremerhaven
An der Karlstadt 8
27568 Bremerhaven / Germany

Phone +49 (0)471 482 3367
bkuether@hs-bremerhaven.de
www.hs-bremerhaven.de

Geschäftsführer Bremische Hafenvertretung (BHV) e. V.

„Die Logistikbranche in Bremen und Bremerhaven kann von dem Projekt BreLogK nur profitieren. Eine nachhaltige und enge Zusammenarbeit zwischen Forschung und Wirtschaft ist wichtig, um Innovationen, insbesondere bei kleinen und mittelständischen Logistikunternehmen, zu fördern.“
The logistics industry in Bremen and

Bremerhaven can only benefit from the BreLogK project. Sustainable and close cooperation between research and industry is vital to promote innovations, especially in small and medium-sized logistics companies.



Klaus Platz

Vorstandsvorsitzender Verein LogistikLotsen für die Metropolregion Nordwest e.V.

„Die LogistikLotsen verfolgen mit Ihren Aktivitäten ganz ähnliche Ziele, wie sie für BreLogK formuliert sind. Die gezielte Vernetzung von Unternehmen der Logistikbranche mit Akteuren aus der Wissenschaft am Standort Bremen/Bremerhaven ist ein wichtiges Element für die Entwicklung innovativer Lösungen. Den Ansatz, im Rahmen von BreLogK eine digitale Lösung für den Vernetzungsprozess und so mehr Transparenz zu schaffen, unterstützen wir gerne.“

The LogistikLotsen pursue very similar goals with their activities as they are formulated for BreLogK. The targeted networking of companies in the logistics sector with scientific players at the Bremen/Bremerhaven location is an essential element for the development of innovative solutions. We gladly support the approach of creating a digital solution for the networking process and thus, more transparency within the framework of BreLogK.

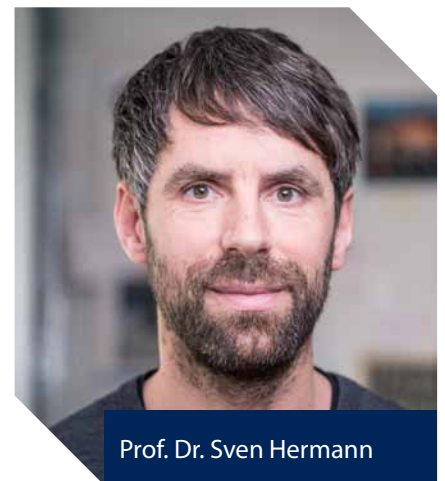

Prof. Dr. Sven Hermann

Geschäftsführer Verein Bremer Spediteure e.V.

„Im Verein Bremer Spediteure, dem Verband für die Speditions- und Logistikbranche, sind rund 150 Unternehmen organisiert. Sie befassen sich überwiegend mit dem Design und der Realisierung von interkontinentalen Lieferketten und Transporten unter Einschluss des See- oder Luftweges. Die meisten dieser Unternehmen sind von ihrer Größe her den klein- und mittelständischen Unternehmen zuzurechnen, deren Ressourcen begrenzt sind, innovative Potenziale zu identifizieren und zu realisieren. Daher begrüßt der Verein Bremer Spediteure außerordentlich die Initiative „Brelogik“ der vier Institute mit Logistikbezug im Lande Bremen, mit einem gemeinsamen Konzept den klein- und mittelständischen Unternehmen einen besseren Zugang zu Innovation zu ermöglichen und somit dazu beizutragen, dass sie ihre Wettbewerbsfähigkeit behalten und weiter stärken.“

Around 150 companies are organized in the Verein Bremer Spediteure, the association for the forwarding and logistics industry. They mainly deal with the design and implementation of intercontinental supply chains and transports, including sea and air transport. Most of these companies are small or medium-sized and have limited resources to identify and realize innovative potential. Therefore, the Bremen Freight Forwarders Association warmly welcomes the “Brelogik” initiative of the four logistics-related institutes in the state of Bremen, which aims to provide SMEs with better access to innovation through a joint concept and thus to help them to maintain and further strengthen their competitiveness.



Robert Völkl



International Doctoral Training in Logistics

Since 2005, the International Graduate School for Dynamics in Logistics (IGS) at the University of Bremen has been offering excellent researchers from all around the world the opportunity to complete an efficient, structured doctoral training at a logistics location with a long-standing tradition. The IGS is embedded in the Bremen Research Cluster for Dynamics in Logistics (*LogDynamics*) and collaborates closely with the industry. The curriculum of the IGS is designed for a full time research doctorate. It bundles interdisciplinary competences and cross-cultural cooperation and fosters the link between research and industry. Besides the individual doctoral project, the curriculum covers collective thematic introductions, subject specific courses, interdisciplinary colloquia, dialogue forums, excursions, as well as individual coaching regarding complementary skills and personality development. The working language of training and thesis is English. However, a basic knowledge of the German language and culture is also required. German IGS doctoral candidates and researchers of *LogDynamics* have the opportunity to participate in a scientific exchange at foreign universities.

Fields of Research

The aim of the IGS is to identify, describe, model and evaluate the required and feasible intrinsic dynamics in logistics processes and networks both an operational and strategic level. It conducts research on innovative dynamic planning and control by using new decision support algorithms and methods, new communication and cooperation arrangements, as well as new technologies. Special topics are adaptive

and dynamic control methods for logistics as well as the synchronization of material and information flows. Against this background, cross-disciplinary cooperation under consideration of intercultural aspects is the basis for research.

The IGS meets the challenge of globalization through practice-oriented research within the scope of fundamental and applied research. The research is centered on four topic areas:

- Business models, decision processes and economic analyses of dynamics in logistics
- Holistic interdisciplinary methods for modelling, analysis and simulation of dynamics in logistics
- Adaptive and dynamic control methods in logistics
- Synchronisation of material, information, decision and financial flows

The curriculum includes individual doctorate projects, disciplinary supervision, scientific mentoring, interdisciplinary cooperation as well as specific training and individual coaching in the field of soft skills.

Supervision

By now, 18 professors from four faculties of the University of Bremen supervised the doctoral candidates of the IGS. Furthermore, all professors of *LogDynamics* are available as supervisors or at least as mentors. Additionally, the early-stage researchers receive a structural supervision and interdisciplinary training by the Managing Director of the IGS, as well as scientific support from the postdoctoral research fellows in their working groups.

Doctoral Project

Working independently on a unique doctoral project is the central research activity in the curriculum of the IGS. In order to fulfil this task under optimal conditions, the doctoral candidates are integrated in the disciplinary research group of their supervisors. Through this assignment, they can benefit from the knowledge and the infrastructure of the respective faculty and institute. Furthermore, they learn to use the tools of scientific work required for their particular project and receive individual support in their research activities.

Courses and Coaching

The training is divided into seminars, workshops, practical training, and integrated learning in small groups and individual coaching. The aim of the disciplinary courses is to educate on the level of international standards of the respective research area. Thematic introductions into the 'other' disciplines and a regular research seminar support the interdisciplinary cooperation at the IGS. Additional course-offers include project management, tools of the craft of research, academic writing for scientific purposes, presentation and communication skills, cross-cultural awareness, language courses, and voice development in English. Each doctoral candidate agrees her/his own training set according to the individual strengths and weaknesses.

Interdisciplinary Research Colloquium

The interdisciplinary research colloquium (IRC) of the IGS offers an institutional and issue-related forum to present and discuss the concept and status of the doctorate projects with all involved faculties. The



young researchers have the opportunity to exchange research results, develop interdisciplinary research questions, and participate in cross-disciplinary discussion groups. Colloquia with all professors of *LogDynamics* or visiting professors ensure targeted impulses for the individual research projects. Research speed dating sessions, poster presentations and World-Café are some of the used methods.

In addition, there is an internal IRC on a weekly basis. Under the guidance of the Managing Director of the IGS, the

doctoral candidates co-operate in the cross-disciplinary and multi-cultural community on a regular basis. After at least three years of training, the doctoral candidates gain an awareness of the differences and develop an individual way to benefit from the diversity, as well as to contribute to the interdisciplinary logistical challenge in fruitful way.

All these elements involve the young researchers in a critical dialogue that – instead of presenting a single dominant perspective – encourages discussions beyond

scientific boundaries and help to create a dynamic, issue-related network. The system of concerted-individual measures ensures the well-directed and effective personnel development through the institutional combination of possibilities and obligation on the path to exchanging ideas actively. This enables the early-stage researchers of the IGS to receive excellent qualifications and helps the university to gain efficient new insights. Furthermore, *LogDynamics* makes its contribution by helping to turn research results into practice.





Alumni of the IGS

By now 76 young scientists from 24 countries started their doctorate with the IGS. The University of Bremen has already awarded 46 of them with a doctoral degree:

Dr.-Ing. Larbi Abdenebaoui, Dipl. Inf.
Mathematics / Computer Science
Graph-Transformational Swarms – A Graph-Transformational Approach to Swarm Computation

Dr.-Ing. Ali B. Alamin Dow, M.Sc.
Physics / Electrical and Information Engineering
Design and Fabrication of a Micro-machining Preconcentrator Focuser for Ethylene Gas Detection System

Dr.-Ing. Mehrdad Babazadeh, M.Sc.
Physics / Electrical and Information Engineering
Plausibility Check and Energy Management in a Semi-autonomous Sensor Network Using a Model-based Approach

Dr.-Ing. Elham Behmanesh, M.Sc.
Production Engineering
A Flexible Integrated Forward / Reverse Logistics Model with Random Path

Dr.-Ing. Marcella Bernardo Pinto, M.Sc.
Production Engineering
Robust Capacitated Vehicle Routing Problem with Uncertain Demands

Dr.-Ing. Jan Ole Berndt, Dipl. Inf.
Mathematics / Computer Science
Self-organizing Supply Networks: Emergent Agent Coordination in Autonomous Logistics

Dr.-Ing. Kateryna Daschkovska, M.Sc.
Production Engineering
Electronic Seals and their Influence on the Dynamics of Container Logistics

Dr.-Ing. Morice Daudi, M.Sc.
Production Engineering
Trust in Sharing Resources in Logistics Collaboration

Dr. Dr.-Ing. Arighna Deb, MTECH
Mathematics / Computer Science
Logic Synthesis Techniques for Optical Circuits

Dr.-Ing. Salima Delhoum, M.S.I.E.
Production Engineering
Evaluation of the Impact of Learning Labs on Inventory Control – An Experimental Approach with a Collaborative Simulation of a Production Network

Dr.-Ing. Nagham El-Berishy, M.Sc.
Production Engineering
Green Logistics Oriented Framework for Integrated Scheduling of Production and Distribution Networks – A Case of the Batch Process Industry

Dr.-Ing. Enzo Morosini Frazzon, MB
Production Engineering
Sustainability and Effectiveness in Global Logistic Systems – An Approach Based on a Long-Term Learning Process

Dr.-Ing. Fasika Bete Georgise, M.Sc.
Production Engineering
Supply Chain Modeling & Improvement of Manufacturing Industry in Developing Countries

Dr. rer. pol. Julie Gould, M.A.
Business Studies / Economics
A Decision Support System for Intermodal Logistics under Considerations for Costs of Safety and Security

Dr.-Ing. Safir Issa, M.Sc.
Physics / Electrical and Information Engineering
Flow Sensors and their Applications to convective Transport in the Intelligent Container

Dr.-Ing. Amir Sheikh Jabbari, M.Sc.
Physics / Electrical and Information Engineering
Autonomous Fault Detection and Isolation in Measurement Systems

Dr.-Ing. Amir Jafari, M.Sc.
Physics / Electrical and Information Engineering
Development and Evaluation of an Autonomous Wireless Sensor Actuator Network in Logistic Systems

Dr.-Ing. Kishwer Abdul Khaliq, M.Sc.
Production Engineering
Vehicular Ad Hoc Network: Flooding And Routing Protocols For Safety & Management Applications

Dr. rer. pol. Arshia Khan, M.phil.
Business Studies / Economics
Supply Chain Management of Mass Customized Automobiles

Dr. rer. pol. Fang Li, M.A.
Business Studies / Economics
Supply Chain GHGs Management under Emission Trading



Summa Cum Laude in IGS

One of the lucky Erasmus Mundus funded doctoral candidates in the IGS has been Kishwer A Khaliq. She came from Islamabad and received a scholarship of a research stay within the project cLINK. She was actually selected for the University of Northumbria, UK, but British visa resistances moved her to the University of Bremen at the last second. It was the young scientist's first stay abroad. Before her arrival, she was worried whether Germany was safe enough for a Muslim woman and then there was the completely foreign language (German!). But all doubts dissolved quickly – on both sides: Security was not an issue in Europe, nor was acceptance in the internationally mixed doctoral training group of the IGS, and research can also be conducted in English in Bremen. After two years of funding by cLINK, she and her supervisor, Prof. Dr. Jürgen Pannek, agreed: A doctorate in the Faculty of Production Engineering at the University of Bremen is a win-win situation for both sides. LogDynamics therefore granted a significant extension of the scholarship from local funds. Kishwer published 16 papers and completed her doctorate in July 2019 – with the highest possible grade! Everybody was happy, even her intended supervisor at Northumbria university: He served as external reviewer in the outstanding graduation of Mrs. Dr.-Ing. Kishwer A. Khaliq at the IGS!

Dr.-Ing. Huaxin Liu, M.Sc.
Production Engineering
A Dynamic Bottleneck-oriented
Manufacturing Control System

Dr.-Ing. Ping Liu, M.Sc.
Production Engineering
Decentralized Robust Capacity Control
of Job Shop Systems with Reconfigurable
Machine Tools

Dr.-Ing. Melanie Luderer, Dipl. Inf.
Mathematics / Computer Science
Control Conditions for Transformation
Units: Parallelism, As-long-as-possible and
Stepwise Control

Dr.-Ing. Safdar Marwat, M.Sc.
*Physics / Electrical and
Information Engineering*
Link Level Scheduling for Future Mobile
Communication

Dr.-Ing. Yasir Mehmood, M.Sc.
*Physics / Electrical and
Information Engineering*
Machine to Machine Communications in
Future Mobile Networks

Dr.-Ing. Afshin Mehrsai, M.Sc.
Production Engineering
Feasibility of Autonomous Logistic
Processes by Reconfiguration of Business
Processes

Dr.-Ing. Elaheh Nabati, M.Sc.
Production Engineering
Understanding and Fulfilling Information
Needs of Stakeholders along Product
Lifecycles - Applying Data Analytics in
Product Life-Cycle Management

Dr. rer. pol. Sylvia Novillo, M.Sc.
Business Studies / Economics
Internationalization of Small and Medium-
sized Enterprises related to their Dynamic
Supply Chain Flexibilities

Dr.-Ing. Javier Palafox, M.Sc.
*Physics / Electrical and
Information Engineering*
Analysis and Prediction of Sensor and
Quality Data in Food Transport Supervision

Dr.-Ing. Nicole Pfeffermann, Dipl.-Ök.
Production Engineering
An Integrated Management Concept
of Innovation Communication and its
Contribution to Company Value

Dr.-Ing. Thomas Pötsch, M.Sc.
*Physics / Electrical and
Information Engineering*
The Efficiency of Transport Protocols in
Current and Future Mobile Networks

Dr.-Ing. Mehdi Safaei, M.Sc.
Production Engineering
Delivery Time Uncertainty in Dynamic
Supply Networks



Achievements of the IGS

Dr.-Ing. Himangshu Sarma, M.Sc.
Mathematics / Computer Science
Virtual Movement from Natural Language Text

Dr.-Ing. Arne Schuldt, Dipl. Inf.
Mathematics / Computer Science
Multiagent Coordination Enabling Autonomous Logistics

Dr.-Ing. Gulshanara Singh, M.Sc.
Physics / Electrical and Information Engineering
Efficient Communication in Agent-based Autonomous Logistics Processes

Dr.-Ing. César Stoll, M.L.I.
Production Engineering
Evaluation of the Application of Automatic Conditions Monitoring of Produce in Fresh Food Warehouses

Dr.-Ing. Muhammad Waseem Tahir, M.Sc.
Physics / Electrical and Information Engineering
Fungus Detection using Computer Vision and Machine Learning Techniques

Dr.-Ing. Yi Tan, M.Sc.
Production Engineering
Extension, Configuration and the Advantages of the Shifting Bottleneck Approach for Solving Dynamic Job Shop Scheduling Problems in Production and Logistics Processes

Dr.-Ing. Vo Que Son, M.Eng.
Physics / Electrical and Information Engineering
Modeling and Implementation of Wireless Sensor Networks for Logistic Applications

Dr.-Ing. Molin Wang, M. Eng.
Production Engineering
A Methodological Concept for Supporting the Commercialization of Electric Vehicles towards Sustainable Urban Freight Transport

Dr. rer. pol. Jiani Wu, M.A. in Management
Business Studies / Economics
Sustainable Freight Village Concepts for Agricultural Products Logistics

Dr.-Ing. Nayyer Abbas Zaidi, M.Sc.
Physics / Electrical and Information Engineering
Development of Optimized Non-dispersive Infrared Sensor Detecting Ethylene Gas in Fruit Containers

Dr.-Ing. David Zastrau, Dipl. Inf.
Mathematics / Computer Science
Estimation of Uncertainty of Wind Energy - Predictions with Application to Weather Routing and Wind Power Generation

Dr. rer. pol. Hongyan Zhang, M.A. in Management
Business Studies / Economics
Knowledge Integrated Business Process Management for Third Party Logistics Companies

Dr.-Ing. Qiang Zhang, M.Sc.
Production Engineering
Nonlinear Model Predictive Control for Industrial Manufacturing Processes with Reconfigurable Machine Tools

Dr.-Ing. Raúl Zuñiga Arriaza, M.Sc.
Production Engineering
Modeling of Supply Chain Processes of the Mineral Raw Materials Industry from the Perspective of EM, SCOR and DCOR Models



LogDynamics contributes to the success story of the University of Bremen in the high-profile area of logistics. The IGS is the educational part of LogDynamics and helps mainly through its ultrahigh degree of internationality and interdisciplinary cooperation in research and education. Since 2015, 76 doctoral candidates out of 24 nations started their doctorate at the IGS at one of the four involved faculties. The University of Bremen has already awarded 46 of them with a doctoral degree.

Sustainable Success of Erasmus Mundus Funding

The IGS has been partner of three Erasmus Mundus mobility projects with Asian regions, funded by the Education, Audiovisual and Culture Executive Agency (EACEA) of the European Commission:

- CLINK – Centre of Excellence for Learning, Innovation, Networking and Knowledge (7.2012-7.2016)
- FUSION – Featured Europe and South Asia Mobility Network (7.2013-5.2018)
- gLINK – Sustainable Green Economies through Learning, Innovation, Networking and Knowledge Exchange (7.2014-12.2018)

Through this funding scheme, scholarships on all academic levels, such as students, doctoral candidates, postdoctoral researchers, and academic staff, had been offered for mobilities in both directions. LogDynamics hosted 46 and sent 7 people in total. 9 of the incomings were doctoral candidates. All doctoral students decided to complete their Ph.D. according to the German education system and as member of the IGS. Therefore, some of them returned to the University of Bremen for their doctoral colloquium or extended their mobility with financial support from the IGS.

By integrating all incoming scholars and guest researchers into the academic training program, the IGS extended and intensified its international foundation through personal experiences. Seven signed Memorandum of Understanding (MoU) complete the picture and are clear indications of the unique sustainable international interdisciplinary profile of the IGS.

IGS as Node between Texas and Ethiopia

One of these success stories is the cooperation with the Texas Tech University (TTU), USA. In summer 2018, the IGS hosted the TTU Ph.D. SummerCamp for Ethiopian lecturers for the second time. Partners were again the Jimma University, Ethiopia, and INROS LACKNER SE. The latter organized excursions to interesting construction and maintenance sites. In winter, LogDynamics and TTU signed a MoU. In summer 2019 the first doctoral candidate from Lubbock, Texas, stayed at the University of Bremen in BIBA to intensify the cooperation in the field of offshore wind energy.

Transferring Soft-skill Training Measures

Another vivid and sustainable cooperation aims to transfer the soft skill training concept of the IGS to the Northern universities in Thailand to develop the young faculties in the Asian state. Measures of the IGS will be part of the Multi-Mentoring System (MMS5) which is currently under development, supported by the Thailand Research Fund. The Chiang Mai University (CMU) is in charge, mainly Prof. Dr. Kate Grudpan, who stayed already several times in Germany, in 2019 as an Alexander-von-Humboldt professor for three months.

CMU and the University of Bremen signed a MoU on universities' level. The CMU initiated a research project to implement an adapted personnel development concept with the support of the IGS. A new Erasmus+ ICM project of the University of Bremen with Thailand will complement the local funding for further exchange.

Sending Logistics Ambassadors into the World

Since the first graduation of a doctoral candidate at the IGS in the year 2008, the alumni and guest researchers of the IGS have been acting as ambassadors of LogDynamics. They represent the high quality of education and research at the University of Bremen. Prof. Dr.-Ing. Enzo Frazzon, alumni of the IGS, serves now as one out of ten privileged Research Ambassadors of the University of Bremen. Furthermore, several cohorts of doctoral candidates of the IGS have been taking part in the annual Bremen/Bremerhaven Logistics Ambassadors training program for several years. All of them will internationally expose the advantages and competences of the logistics location Bremen. Due to this international awareness, an increasing number of young researchers apply to the IGS, and the community is continuously growing.





Guests of the IGS

Prof. Dr. Mujtaba Hassan Agha
Capital University of Science and Technology,
Islamabad, Pakistan

Getachew Basa Bonsa
Ph.D. candidate of Mekelle University, Ethiopia

Supansa Chaising
gLINK fellow of Transport and Traffic Studies,
Mae Fah Luang University, Chiang Rai,
Thailand

Prof. Stephen Ekwaro-Osire, Ph.D.
Department of Mechanical Engineering, Texas
Tech University, Lubbock, U.S.A.

Prof. Dr.-Ing. Enzo Morosini Frazzon
Federal University of Santa Catarina (UFSC),
Brazil

Prof. Dr. Teresa Gonçalves
Local coordinator of FUSION and gLINK
Department of Informatics, University of
Évora, Portugal

Prof. Dr. Kate Grudpan
Center of Excellence on Innovation in
Analytical Science and Technology, Chiang
Mai University, Thailand

Werku Koshe Hareru
Ph.D. candidate of Jimma Institute of
Technology, Ethiopia

Dr. Sri Yogi Kottala
gLINK fellow of Business Studies with
Technology, Indian Institute of Technology
Roorkee, India

Dr. Guiqing Liu
Associate professor of Economic Manage-
ment, Zhongyuan University of Technology,
Henan Province, China

Dave A. Louis, Ph.D.
Associate professor of Higher Education
Department of Educational Psychology
& Leadership, Texas Tech University,
Lubbock, U.S.A.

Prof. Dr. Mend-Amar Majig
gLINK fellow, TT of Production Engineering,
National University of Mongolia,
Ulaanbaatar, Mongolia

Asrat Mekonnen Gobachew
Ph.D. research student of Addis Ababa
Institute of Technology, Ethiopia

Abraham A. Nispel
Graduate Research Assistant of the
Department of Mechanical Engineering, Texas
Tech University, Lubbock, U.S.A.

Tamiru Paulos Orkodjo
Ph.D. candidate of Jimma Institute of
Technology, Ethiopia

Matheus Cardoso Pires
Ph.D. candidate of the Federal University of
Santa Catarina, Florianópolis, Brazil

Feseha Sahile Asrat
Ph.D. candidate of Jimma Institute of
Technology, Ethiopia

André Luyde da Silva Souza
Master student in Computer Science
Federal University of Ouro Preto (UFOP), Minas
Gerais, Brasilien

Satie L. Takeda Berger
Ph.D. candidate of the Federal University of
Santa Catarina, Florianópolis, Brazil

Tenaw Tegbar Tsega
Ph.D. candidate of Bahir Dar University,
Ethiopia

Iracyanne Uhlmann
Ph.D. candidate of Federal University of Santa
Catarina, Florianópolis, Brazil

Pei Wang, Ph.D.
Lecturer of the Department of Logistics
Engineering, School of Traffic and
Transportation, Beijing Jiaotong University,
China

Siraprapa Wattanakul
Ph.D. candidate of Université Lumière Lyon 2
Erasmus Mundus fellow from Chiang Mai
University, Thailand

Li Xin
Master student in the department of
Architecture and Urban Planning, Tongji
University, China



Robust Solution Approach for the Stochastic Vehicle Routing Problem

We propose a solution approach for the Stochastic Capacitated Vehicle Routing Problem (SCVRP). We formulated the problem as a two-stage stochastic program model with recourse. In the first stage the a priori route plan cost is minimized, whereas in the second stage the average of higher moments for the recourse cost calculated via a set of scenarios is minimized. The goal is to compute a robust solution that minimizes transportation costs while permitting small changes in the demands. The approach allows managers to choose between optimality and robustness. The results show that the robust solution can cover for unmet demand while incurring little extra costs. We observed that as the route plan is more robust, the expected real cost and the increment within the planned cost are lower.

Introduction >>> The Vehicle Routing Problem (VRP) aims to determine a set of vehicle routes to perform transportation requests with a given vehicle fleet at minimum cost, i.e., to decide which vehicle handles which customer order in which sequence. In this kind of problem, one typically assumes that the values of all inputs are known with certainty and do not change. Nevertheless, in real case applications, the exact values of customer demands are often uncertain or even unknown. Such situations can be modelled by using the Stochastic Capacitated Vehicle Routing Problem (SCVRP).

Usually, solution methods for the SCVRP are classified into one of two families: stochastic modeling or sampling. In stochastic modeling approaches, the stochastic knowledge is formally included in the problem formulation, but they are highly technical in their formulation and require to efficiently compute possibly complex expected values. On the other hand, sampling has relative simplicity and flexibility on distributional assumptions, while its drawback is the massive generation of scenarios to accurately reflect reality [2] [12]. These approaches sample the probability distributions to generate scenarios that are used to make decisions.

Different authors have proposed sampling-based approaches in the context of stochastic VRP, for instance, the Multiple Scenario Approach (MSA) proposed by Bent and Van Hentenryck [4] and Sample Average Approximation (SAA) method applied in Verweij et al. [16]. <<<

Stochastic Vehicle Routing Problem

In this paper, we formulate the stochastic capacitated vehicle routing problem, where the demands are stochastic, as a two-stage stochastic program with recourse, using a detour to the depot as the corrective action. Similar to the sampling-based methods, we also make use of scenarios in the proposed robust solution approach. However, different from MSA, the scenarios are generated only once at the beginning of the planning stage and different from SAA, we do not minimize the average of the second-stage cost of a set of sample scenarios. The idea of the robust approach is to address uncertainty using higher moments calculated via scenarios, permitting the solution to be able to adapt to situations when the real demand is greater than expected. Our aim is to develop a solution approach such that the route plan is robust against small changes in the inputs,

i.e., allowing to compensate changes in the input without losing structural properties and optimality. For that, the remainder of the paper is organized as follows. Section 2 describes the robust solution approach. This is followed in Section 3 by the computational results, and last, Section 4 concludes with a summary.

Robust Solution Approach

For the SCVRP, we develop a robust solution approach. The proposed approach includes four stages: distribution fitting, generation of scenarios, the definition of a static and deterministic CVRP and optimization. In the distribution fitting stage, we fit a probability distribution function (PDF) to customer demand data by using historical demand data. After that, in the generation of scenarios stage, we use this PDF to generate S scenarios. Each scenario represents a potential state of the uncertain demand for every customer. For scenario 0 (nominal scenario), it is assumed that all N customers demand are equal to the expected value of the probability distribution ($d_n(0) = E[d_n]$).

The other scenarios are constructed by sampling the demand probability distribution using Monte Carlo Simulation. Note that, instead of using the existing customer demand scenarios (historical data), we

Marcella Bernardo*



generate new scenarios. We choose this because in some situations, using historical data as a scenario may be impractical. For example, a new company may not have enough data for generating a higher number of scenarios. In the third stage, a static and deterministic instance of the capacitated DSVRP is set by using equation

$$\bar{d}_n = d_n(0) + \omega \sum_{s \in S} \frac{d_n(j) - d_n(0)}{\bar{s} - 1} \quad (1)$$

$$\forall n \in N.$$

Every customer demand (\bar{d}_n) is calculated by a linear combination of the S scenarios with the weight ω , which increased the deviation from the expected value ($d_n(0)$), allowing to create worse case instances. Hence, it is possible to decide how conser-

vative a solution can be. The instance set in this stage is then used in the optimization stage. Since a capacitated DSVRP is set, we can make use of the efficient well-established heuristics in the literature to solve the robust problem. In the fourth and last stage we solve the instance defined in the previous stage. For that, we use three heuristics: Clark Wright savings, 2-opt Local Search and, Simulated Annealing. The result obtained after this optimization stage is a route plan. This route plan is robust concerning certain deviations in demands.

Computational Results

We generated five benchmark test problems ($q \in 1, 2, 3, 4, 5$). They consist of fully connected graphs with ($N \in 20, 40, 60, 80, 100$) nodes. Considering that the graph

is symmetric, several arcs were generated equal to $A = N \cdot (N - 1)/2$. The instances exhibit only capacity restrictions. We considered for all test problems the demand to be uniformly distributed $d_{TPq,i} \sim U(30, 70)$ for all customers.

After developing the dynamic benchmark dataset, we applied the proposed solution approach to the dataset using a total of $S = 10$ scenarios. We applied the robust solution approach for $\omega \in \{0, 1, 2, 3, 4, 5\}$ to every test problem and solved it to optimality, with the maximum CPU time set to one hour. It is important to highlight that we do not want either to define a set of values for ω or an upper bound on it. We want to analyze how solutions designed for different w perform. For each value of ω , we obtained six plans of routes, which

Table 1: Results for the test problems considering the weight ω

Test Problem	ω	P_{plan} (failure)	Number of Routes	P_{routes} (failure)	Planned Cost	Extra Cost	Expected Real Cost	ΔD	I	CPU
TP1	0 (mean)	0.87	4	0.37	1471	-	1817	346	1.23	8976
	1	0.79	5	0.30	1634	1.11	1810	176	1.10	8999
	2	0.77	5	0.28	1634	1.11	1807	173	1.10	9133
	3	0.76	5	0.25	1643	1.11	1720	77	1.04	9567
	8	0.59	5	0.19	1700	1.12	1879	163	1.09	9822
	10	0.52	5	0.10	1772	1.20	1901	129	1.07	10790
TP2	0 (mean)	0.98	8	0.42	2592	-	3250	658	1.25	20509
	1	0.98	9	0.40	2747	1.05	3257	510	1.18	20902
	2	0.90	9	0.39	2747	1.05	3221	474	1.17	21112
	3	0.70	9	0.35	2769	1.06	3155	386	1.13	21678
	8	0.68	10	0.27	2807	1.08	3467	660	1.23	22487
	10	0.65	10	0.25	2861	1.08	3441	580	1.21	22756
TP3	0 (mean)	0.99	12	0.44	3690	-	4969	1279	1.34	38234
	1	0.99	14	0.42	3944	1.06	4965	1021	1.25	39877
	2	0.90	14	0.38	3952	1.06	4960	1008	1.25	43234
	3	0.89	14	0.33	3941	1.06	4875	934	1.23	43654
	8	0.88	14	0.30	3998	1.07	5023	1025	1.25	44877
	10	0.80	16	0.24	24184	1.32	5268	18499	1.75	51001
TP4	0 (mean)	1.00	16	0.46	4882	-	6757	1875	1.38	51667
	1	1.00	18	0.46	5232	1.07	6754	1522	1.29	57100
	2	1.00	18	0.40	5294	1.07	6753	1459	1.27	57212
	3	1.00	18	0.42	5294	1.07	6739	1445	1.27	57302
	8	1.00	18	0.35	5351	1.09	6702	1351	1.25	5804
	10	1.00	19	0.23	5415	1.10	6675	1260	1.23	62200
TP5	0 (mean)	1.00	20	0.46	6057	-	8402	2345	1.38	72865
	1	1.00	22	0.40	6278	1.03	8401	2124	1.33	76965
	2	1.00	22	0.40	6296	1.03	8395	2099	1.33	77102
	3	1.00	22	0.41	6278	1.03	8390	2112	1.33	77000
	8	1.00	22	0.37	6329	1.04	8370	2041	1.32	77590
	10	1.00	23	0.33	6354	1.04	8372	2018	1.31	85786
TP6	0 (mean)	1.00	24	0.47	7253	-	10002	2749	1.37	100856
	1	1.00	26	0.42	7436	1.02	9987	2551	1.34	114502
	2	1.00	26	0.40	7543	1.03	9980	2437	1.32	115121
	3	1.00	26	0.40	7514	1.03	9912	2398	1.31	115031
	8	1.00	26	0.37	7550	1.04	10020	2470	1.32	115672
	10	1.00	28	0.38	7585	1.05	10140	2555	1.33	120876

Figure 1: Route Plan without Route Failure

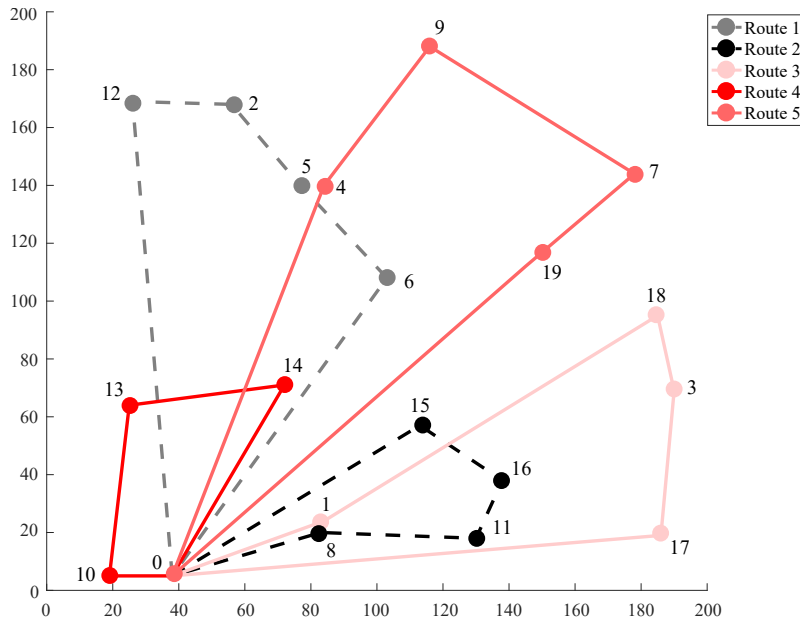
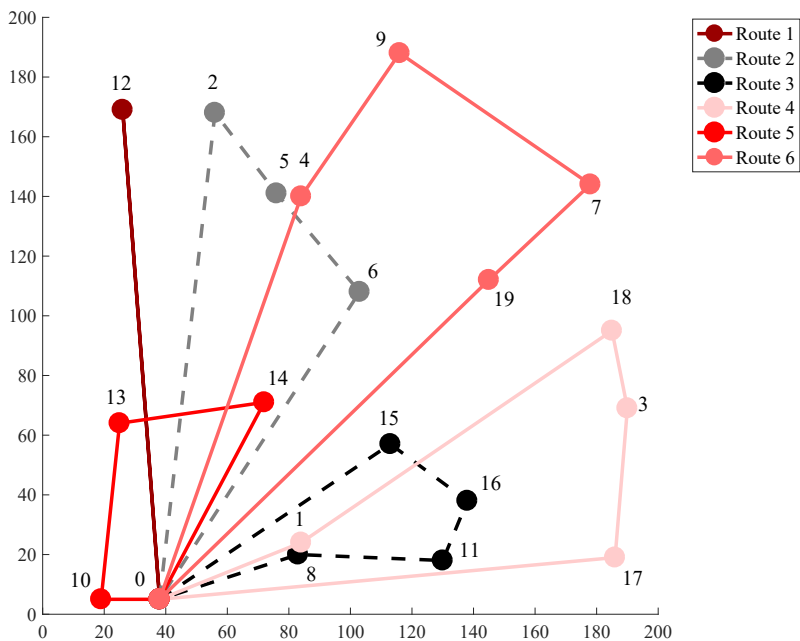

Figure 2: Route Plan after Corrective Actions Were Applied



represent different degrees of robustness. It is important to highlight that when we choose $\omega = 0$, we are using the nominal solution of the corresponding deterministic model. To compare these solutions, we introduced four performance measures: reliability of a route plan $P_{plan}(failure)$, probability of route failure $P_{route}(failure)$, extra cost E of the robust plan and expected real cost of a route plan.

From our results given in Table 1 we observed that for TP1, TP2 and TP3 the probability of plan to fail $P(failure)$ is lower using a higher ω . For TP4, TP5 and TP6 however, the probability of route plan to fail remained unchanged for all ω . This

performance measure does not consider how many routes within the route plan failed. For that, we evaluate the route plans regarding performance measure Probability of Route Failure. Thus, the route plans with the same probability of plan failure can also be compared. For instance, in TP5 the route plan obtained using $\omega = 1$ and $\omega = 10$ have the same probability of plan failure. However, for $\omega = 1$ these failures occur on 40% of the routes, on the hand for $\omega = 10$ this amount decreases to 33%. A lower probability of failure or higher reliability of a route plan comes associated with a price, as mentioned before, the Extra Cost (the price of robustness). Under the

price of robustness, we accept a suboptimal solution (higher cost) to ensure that the solution is more robust, and remains feasible and near optimal when the data changes [6]. Hence, for all test problems, growth in the w causes an increase in the Extra Cost. This cost is no higher than 32%. Actually, for all test problems, the extra cost varied between 3% and 11%. Only for $\omega = 10$ in Test Problem 1 and three, the extra cost was higher than this range.

For all test problems, the Expected Real Cost was higher than the planned cost. This indicates that detours to the depot were applied in all route plans of all test problems to meet the real demands. It also means that at the end (after second-stage) we have more routes than planned (in the first stage). For instance, for TP1 and $\omega = 8$, the route plan is composed of 5 routes, see Fig. 1. However, when we use this plan to attend the same customers, but now assuming the real values for the demands, we have six routes, see Fig. 2. Hence, one route has failed, and therefore, more routes are required to attend the same clients. For example, the customer 12 was included in the route {0-6-5-1-12-0} (Fig. 1); however, when the real demands are revealed, the total demand for this route is higher than expected. Thus, a vehicle needs to attend the customer 12 in only one route (2). It can be observed that the expected real cost behaved differently for different test problems. For TP1, TP3 and TP6 the expected real cost decreased from $\omega = 0$ to $\omega = 3$ and increase from $\omega = 8$ to $\omega = 10$. For TP4 such cost decreased from $\omega = 0$ to $\omega = 10$. Any pattern in the behavior could be noticed for TP2. We can then infer that for almost all test problems the route plan designed with $\omega = 3$ is the most robust, i.e., the route plan handle better changes in the demands. Most of the solution calculated for $\omega = 3$ needed fewer detours to the depot to deal with the real values of the demands compared to the other solutions in each test problem. Since the solutions calculated for $\omega = 10$ did not always present the best performance over all solutions, one may also conjecture that a higher degree of robust may not pay off.

Comparing CPU time for the same instance, we see that increases on ω cause growth on CPU time. Comparing CPU time for different instances, we detect that more customers represent higher CPU time. However, the maximum CPU time was not reached.

Conclusion

We proposed a robust solution approach for the stochastic CVRP, where demands are uncertain. We formulate the problem as a two-stage stochastic program model with recourse. A detour to the depot was defined as corrective action. Different from the other sampling-based methods for the SCVRP, the proposed solution approach permits deciding between optimality and robustness and computes an a-priori robust route plan, which allows for small changes in demands without changing solution structure and losing optimality. Using the robust approach, the SCVRP is reduced to capacitated static and deterministic VRP, which allows using simple algorithms. The results show that the proposed approach provides significant improvements over the deterministic approach. It is evident that the proposed idea provides a robust route plan.

That is, for some ω , the reliability increased, and the probability of route failure, extra cost and expected real cost decreased. The robust solutions are not associated with a high price of robustness, that is for $w \in \{0, 1, 2, 3, 8, 10\}$ the extra costs are less than 32% of the optimal cost.

Additionally, it is worth mentioning that the proposed solution approach provides the lowest expected real cost – i.e., the real cost we must pay after a working day. We like to note that for some situations it is better to choose robustness over optimality, i.e., it is better to apply the proposed robust solution approach over the deterministic approach, to be safe against a worse case realization of the uncertainty. Although the proposed approach comes out with advantages, it still has some limitations. First, we need to have historical data about the uncertain input to be able to fit a probability distribution. Second, we have to assume information about the

probability distributions of the uncertain parameters, i.e., the underlying demand probability distributions must be known.

References

- [1] Aarts, E. and Lenstra, J. K. (1997). *Local Search in Combinatorial Optimization*. John Wiley & Sons, Inc., New York, NY, USA, 1st edition.
- [2] Abbatecola, L., Fanti, M. P. and Ukovich, W. (2016). A review of new approaches for dynamic vehicle routing problem. *IEEE International Conference on Automation Science and Engineering (CASE)*, pp. 361–366.
- [3] Barbucha, D. (2009). *Simulating Activities of the Transportation Company through Multi-Agent System Solving the Dynamic Vehicle Routing Problem*. In Håkansson, A., Nguyen, N.T., Hartung, R.L., Howlett, R.J. and Jain, L.C., *Agent and Multi-Agent Systems: Technologies and Applications*. Springer, Berlin, Heidelberg. doi: 10.1007/978-3-642-01665-3_78.
- [4] Bent, R. and Van Hentenryck, V. (2004). Scenario-based planning for partially dynamic vehicle routing with stochastic customers. *Operations Research*, 52(6), pp. 977–987.
- [5] Bernardo, M. and Pannek, J. (2018). Code information and dynamic benchmark dataset, https://www.researchgate.net/publication/322132039_Robust_Method_for_the_Dynamic_and_Stochastic_Capacitated_Vehicle_Routing_Problem_DSCVRP_with_uncertain_demands, seen on June 12, 2019
- [6] Bertsimas, D. and Sim, M. (2004). The price of robustness. *Operations Research*, 52(1), pp. 35–53.
- [7] Chen, H. K., Hsueh, C. F. and Chang, M. S. (2006). The real-time time-dependent vehicle routing problem. *Transportation Research Part E: Logistics and Transportation Review*, 42(5), pp. 383–408.
- [8] Christophides, N. and Beasley, J. (1984). The period problem. *Networks*, 14, pp. 237–256.
- [9] Clarke, G. and Wright, J. W. (1964). Scheduling of Vehicles from a Central Depot to a Number of Delivery Points. *Operations Research*, 12(4), pp. 568–581.
- [10] Lin, C., Choy, K. L., Ho, G. T. S., Lam, H. Y., Pang, G. K. H. and Chin, K. S. (2014). A decision support system for optimizing dynamic courier routing operations. *Expert System with Applications*, 41, pp. 6917–6933.
- [11] Marinakis, Y., Iordanidou, G. and Marinaki, M. (2013). Particle swarm optimization for the vehicle routing problem with stochastic demands. *Applied Soft Computing*, 13(4), pp. 1693 – 1704. ISSN 1568-4946. doi: <https://doi.org/10.1016/j.asoc.2013.01.007>.
- [12] Pillac, V., Michel, G., Gueret, C. and Medaglia, A. L. (2013). A Review of Dynamic Vehicle Routing Problems. *European Journal of Operational Research*, 225, pp. 1–11.
- [13] Secomandi, N. (2003). Analysis of a rollout approach to sequencing problems with stochastic routing applications. *Journal of Heuristics*, 9(4), pp. 321–352.
- [14] Solomon, M. M. (2014). Algorithms for the vehicle-routing and scheduling problems with time window constraints. *Operations Research*, 35(2), pp. 1035–1044.
- [15] Van Laarhoven, P. J. M. and Aarts, E. H. L. (1987). *Simulated annealing*, Springer, Netherlands, Dordrecht, pp. 7–15.
- [16] Verweij, B., Ahmed, S., Kleywegt, A. J., Nemhauser, G. and Shapiro, A. (2003). The sample average approximation method applied to stochastic routing problems: A computational study. *Computational Optimization and Applications*, 24(2), pp. 289–333. ISSN 1573-2894. doi: 10.1023/A:1021814225969.
- [17] Zhu, L., Rousseau, L., Rei, W. and Li, B. (2014). Paired cooperative reoptimization strategy for the vehicle routing problem with stochastic demands. *Computers & Operations Research*, 50, pp. 1–13.

*Co-Author

Jürgen Pannek



Marcella Bernardo Pinto, M.Sc.

Email: ber@biba.uni-bremen.de
Country: Brazil
Start: 01.03.2016
Supervisor: Prof. Dr. Jürgen Pannek
Faculty: Production Engineering
Research Group: Dynamics in Logistics
Funded by: Ciência sem Fronteiras - CNPq

Surface Functionalization of Polyimide Substrates for Microsensors' Applications

The use of embedded microsensors is a promising approach for health monitoring of fiber reinforced composites. We are going to evaluate surface modification methods for polymer substrates used in strain microsensor. In this first stage, oxygen plasma treatments with different power and time were used to functionalize Polyimide surface. The evaluation of these treatments was carried out by means of distilled water contact angle measurements. The results shown the best conditions for polymer surface functionalization.



Introduction >>> Fiber reinforced polymer composites (FRPCs) are of high importance in the automotive, aeronautical and aerospace fields. For this reason, it is desirable to perform a continuous assessment of the loads and strain applied during their service life. This diagnosis is known as structural health monitoring [1].

Among the current approaches for FRPCs health monitoring, self-sensing materials are a promising field that can be obtained using embedded sensors for real-time monitoring [2]. However, it is necessary to minimize the "wound" effect in host FRPCs caused by the microsensor inclusion [3,4]. One way to overcome this limitation is the use of thin and flexible microsensors, based on polymeric substrates [5,6]. Nevertheless, the adhesion between the microsensor and the host FRPCs strongly depends on the chemical nature of the microsensor's surface. Therefore, some sort of microsensor surface modification is required for a proper bonding [3,7]. <<<

Polymer Surface Modification

One current approach for the integration of strain microsensors within FRPCs relies on perforation patterns to allow resin flow through the sensor during the FRCP manufacture [8-10]. However, there is a remaining surface area that has no chemical bonding with the resin.

Improvement of the adhesion between the microsensor and the host FRPC may be accomplished by microsensor surface functionalization using oxygen plasma treat-

ments. It allows the grafting of hydroxyl functional groups on polymer surface [11, 12]. Another method for functionalization is wet chemistry using bifunctional and polyfunctional amines based treatments, which allow the grafting of amine molecules [13,14]. Given that the target host composite is an epoxy resin based FRPCs, both hydroxyl and amine groups are desirable for covalent bonding with the resin.

Research Method

Polyimide was selected as a substrate for strain microsensors due to its thermal and mechanical properties. The proposed methodology is represented in Figure 1. For fabrication of polymer substrates, silicon wafers were spin-coated with prepolymer Varnish-S and thermally polymerized.

For functionalization of the Polyimide two different oxygen plasma tools were used, the chamber Tepla 400 microwave plasma system and the STS Multiplex ICP Reactive Ion Etcher (RIE). Treatments with each tool involved a combination of three different power levels and three different

treatment times for each power level. For microwave plasma the combination was 250, 500 and 1000 Watts, with times of 0.5, 1 and 5 min for each power level. In the case of the RIE, treatments with acceleration power of 10, 25 and 50 Watts, and times of 0.25, 0.5, and 1 min were used.

Distilled water contact angle of the coated wafers was measured after the plasma treatments. Due to the formation of hydroxyl groups on the polymer surface, hydrogen bonding with distilled water should lead to an increment of Polyimide wettability, observed as a reduction in the water contact angle. For stability evaluation of treatments, the measurements were registered for 14 days.

Results

Measurements of Polyimide thickness coating shown an average value of 4.6 μm . Evaluation of thickness in different samples and sections indicated a fairly homogenous polymer coating.

Regarding the wettability of treated surfaces, the lowest contact angle ($\sim 3^\circ$) for

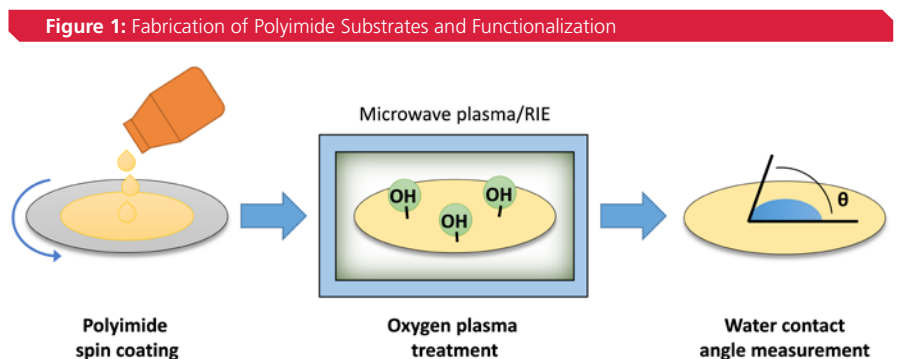

the microwave plasma treatments was obtained with a power of 1,000 Watts, independently of the treatment time. Meanwhile, for the RIE plasma tool, the lowest angle ($\sim 13^\circ$) was achieved with a combination of 50 Watts power and a treatment time of 1 min. For comparison purposes, measurements of pristine polymer were also included in the plots of the mentioned treatments in Figure 2. The evolution of contact angle as a function of time shown more stable values during the first two days for microwave plasma only treatment. Given these results, a better adhesion between Polyimide and host FRCP is expected for treatments with the lowest contact angle. On the other hand, thickness measurements of polymer coating did not indicate a significant etching of the Polyimide layer in the case of the wafers treated with the microwave plasma. However, the results for the RIE tool indicated etching of more than $0.5 \mu\text{m}$, which must be considered during the future manufacture of microsensors.

Conclusions and Outlook

It was found that plasma treatments for surface functionalization of polyimide have increased the wettability of the polymer surface. In general, higher power and longer time led to higher wettability.

However, polymer etching must be considered for future fabrication of complete strain sensors. Future work will involve the use of the selected plasma treatments to promote the adhesion of Polyimide inlays within epoxy/fiber composites. Also, a second approach involving amines based treatments will be compared with plasma treatments.

Figure 2: Water Contact Angle Measurements of Plasma Treatments

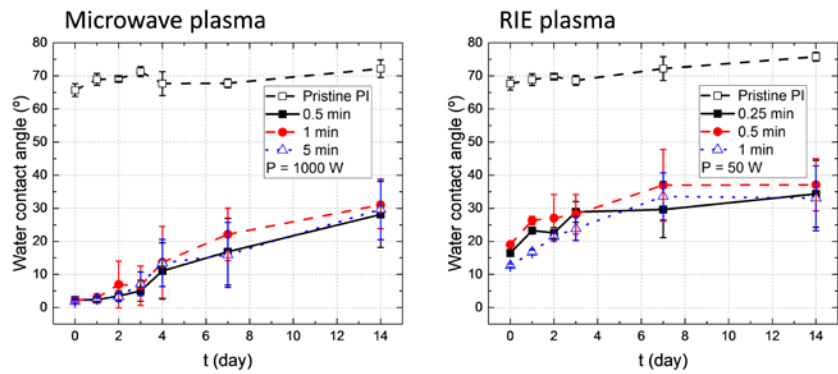

References

- [1] Karbhari, V. M. (2013). *Non-Destructive Evaluation (NDE) of Polymer Matrix Composites*. Elsevier.
- [2] Balageas, D., Fritzen, C.P. and Güemes, A. (2006). *Structural Health Monitoring*. ISTE.
- [3] Chung, D. D. L. (2007). *Damage detection using self-sensing concepts*. Proceedings of the Institution of Mechanical Engineers, Part G: Journal of Aerospace Engineering, 221(4), pp. 509-520. <https://doi.org/10.1243/09544100JAERO203>
- [4] Hautamaki, C., Zurn, S., Mantell, S. C. and Polla, D. L. (1999). *Experimental evaluation of MEMS strain sensors embedded in composites*. Journal of Microelectromechanical Systems, 8, pp. 272-279.
- [5] Dumstorff, G., Paul, S. and Lang, W. (2014). *Integration Without Disruption: The Basic Challenge of Sensor Integration*. IEEE Sensors Journal, 14, pp. 2102-2111.
- [6] Dumstorff, G. and Lang W. (2015). *Investigations on the impact of material-integrated sensors with the help of FEM-based modeling*. Sensors, 15, pp. 2336-2353.
- [7] Schotzko, T., Gräbner, D. and Lang, W. (2016). *Strain gauges based on NBR substrates for the integration into elastic materials*. Materials Letters, 172, pp. 60-63.
- [8] Hübner, M., Gräbner, D., Özdemir, A. and Lang, W. (2018). *Influence of strain on miniaturized flexible sensor for on-line monitoring of CFRP production*. Procedia Manufacturing, 24, pp. 173-178.
- [9] Hübner, M. and Lang, W. (2017). *Online Monitoring of Composites with a Miniaturized Flexible Combined Dielectric and Temperature Sensor*. Proceedings, 1, p. 627.
- [10] Kahali Moghaddam, M., Breede, A., Chaloupka, A., Bödecker, A., Habben, C., Meyer, E. M., et al. (2016). *Design, fabrication and embedding of microscale interdigital sensors for real-time cure monitoring during composite manufacturing*. Sensors and Actuators A: Physical, 243, pp. 123-133.
- [11] Kim, J. K. and Mai, Y. W. (1998). *Engineered interfaces in fiber reinforced composites*. Oxford. Elsevier science.
- [12] Friedrich, J. (2012). *The Plasma Chemistry of Polymer Surfaces*. Wiley-VCH.
- [13] Albrecht, W., Seifert, B., Weigel, T., Schossig, M., Holländer, A., Groth, T., et al. (2003). *Amination of Poly(ether imide) Membranes Using Di- and Multivalent Amines*. Macromolecular Chemistry and Physics, 204, pp. 510-521.
- [14] Yun, H. K., Cho, K., Kim, J. K., Park, C. E., Sim, S. M., Oh, S. Y., et al. (1997). *Adhesion improvement of epoxy resin/polyimide joints by amine treatment of polyimide surface*. Polymer, 38, pp. 827-834.

*Co-Author

Walter Lang



Marco Cen, M.Sc.

Email: MCen@imsas.uni-bremen.de
 Country: Mexico
 Start: 01.10.2018
 Supervisor: Prof. Dr. Walter Lang
 Faculty: Physics / Electrical Engineering
 Research Group: Institute for Microsensors, -Actuators and -Systems (IMSAS)
 Funded by: CONACYT - DAAD

Simulation-based Optimization in Supplier Development

Facing increasingly competitive challenges, many organizations consider supplier performance as an important contributor to their competitive advantage. Supplier development is one of the recent approaches to supplier performance enhancement and consistently requires relationship-specific investments. It is important to invest money on a supplier to minimize risk while maintaining an acceptable level of return. Here, we consider a multi-manufacturer centralized and distributed setting that enables us to simulate more realistic possibilities. By imposing model predictive control, we aim to simulate and minimize the risk of future investments of manufacturers.



Introduction >>> Manufacturing companies face procurement costs associated with raw materials and components in excess of 50% of the companies' total profit (Reed and Walsh 2002; Talluri et al. 2010). As a result, manufacturers depend on their suppliers (ibid.) and their performance has a considerable effect on many product aspects, such as cost, quality and on-time delivery (Talluri et al. 2010). Consequently, manufacturers place increasing emphasis on effectively working with suppliers by supplier development. The purpose of supplier development is to enhance the performance and/or capabilities of the supplier and to meet the supply needs of manufacturers, such as improvement in response to customer needs and market dynamics, increasing customer responsiveness, improvement of quality and reliability of products, manufacturing of new products, reducing costs of production and ultimately, to increase profit margins (Govindan et al. 2010; Bai and Sarkis 2010; Talluri et al. 2010). <<<

Related Literature

In the past decades, supplier development has received notable attention from researchers (Wagner 2006; Krause et al. 2007; Krause and Scannell 2002; Kruse and Ellram 1997; Bai and Sarkis 2010; Reed and Walsh 2002; Talluri et al. 2010). Former research provided deep insights into the use of certain operations in the supplier development context (Wagner 2006), the antecedents (Krause 1999), important success elements (Wagner 2011), and the propagation of supplier development in applications (Krause and Scannell 2002). In variant industries, supplier development has been utilized (Talluri et al. 2010). In the automotive industry, Toyota started preparing on-site support (Sako 1990), in order to include suppliers into the Toyota Production System. Boeing, Chrysler, Daimler, Dell, Ford, General Motors, Honda, Nissan, Siemens, and Volkswagen followed this collaborative procedure to develop suppliers' performance and/or capabilities (Routroy and Pradhan 2013).

Therefore, engaged parties have to decide between formal contracts, which represent a formalization as protection against opportunism and relational contracting, which relies more on a relational mechanism to enhance successful exchanges. Relationship-specific investments conduce to more adequate results. According to (Wagner 2011), supplier development is more effective in mature stages in comparison with primary phases of relationship life cycles. Dyer and Singh 1998) added that adequate protection mechanisms might affect both dealing costs and inclination of companies to invest relationship-specific resources in supplier development. In the first case, companies achieve an advantage by incurring fewer transaction costs to identify a defined level of supplier development specificity. In the second case, companies create relational rents by obtaining a higher level of property specificity (Dyer 1996).

Model Description

We expand the setting from Worthmann et al. 2016) to a multi-manufacturer structure, which consists of two manufacturers M_1 and M_2 and a single supplier S , cf. Figure 1. While S provides components to M_1 and M_2 , manufacturers assemble these components to final products and sell these to the market.

Model predictive control (MPC) consists of two different control loops: a closed loop control, which applies short-term control decisions to the real world system

Figure 1: Multi-manufacturer Supply Chain Structure

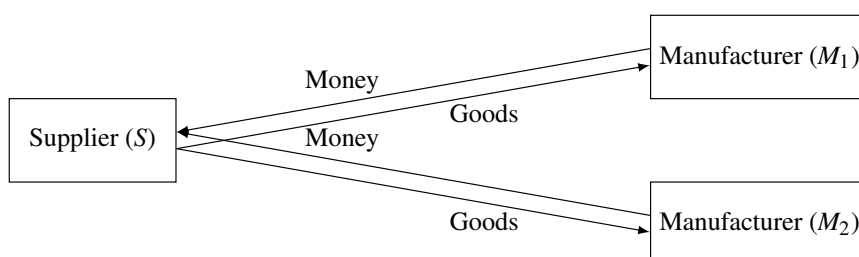

and receives feedback about their effects, and an open loop simulation, which acts as the foundation for the long-term optimization. Figure 2 sketches the overall scheme, where the real world system is shown on top of the figure, which refers to the two manufacturers and a supplier. The real world system receives control input from the closed-loop control at predefined time steps t_i and provides feedback in terms of a measured state of the system x_m and a measured time step t_m to the closed-loop control. The closed loop control uses this information to initiate an open loop simulation-based optimization. In contrast to the closed loop, the open loop covers an increased time horizon of N time steps. As no real-world feedback can be obtained, the effects of control decisions u_i with $i \in t_m \dots (t_m + N)$, are simulated using an underlying system model and the control sequence $u_{t_m} \dots u_{t_m+N}$ is optimized using a provided cost function. The latter is not shown in the picture but is assumed to be part of the optimization. The obtained optimal control sequence for N time steps is then returned to the closed-loop control, which forwards the first element of this sequence u_{t_m} to the real world system as control decision for the current time step. After application, a new measurement is conveyed to the closed-loop control and the overall cycle restarts.

Derivation of the Optimizer's Cost Function

We consider a linear price distribution curve $p(d) = a - b \cdot d$, where d represents the production quantity and p represents the sale price, cf., e.g., (Bernstein and Kok 2009; Kim 2000; Li et al. 2012; Worthmann et al. 2016), and where $a > 0$ and $b > 0$ denote the prohibitive price and the price elasticity of the production.

Note that this system shows only one decision variable, which is given by the sales of the manufacturer. The supplier cannot take a decision with regards to production quantity and just produces the components to satisfy the market demand d . Due to profit maximization, the production quantity d chosen by M is determined by the zero of the first derivative of the profit given by $d(p(d) - c_M - c_{SC})$, where c_M and c_{SC} denote the unit production costs of M the supply costs per unit of S , cf. (Worthmann et al. 2016; Proch et al. 2017). Hence, we obtain

$$p(d) - c_M - c_{SC} - b \cdot d = 0$$

and thereby the optimal production quantity and optimal sale price

$$d^* = \frac{a - c_M - c_{SC}}{2b} \quad p(d^*) = \frac{a + c_M + c_{SC}}{2}$$

where $c_0 > 0$ represents the base unit pro-

duction cost of the supplier S , and $m < 0$ characterizes its learning rate. Last, x defines the cumulative number of realized supplier development projects, which can be changed by the manufacturer M via $u \in [0, \omega]$. The bound $\omega > 0$ represents a resources availability limitation, which can be time, manpower, or budget.

$$J_T(u; x_0) = \int_0^T \frac{(a - c_M - c_0 x(t)^m)^2 - r^2}{4b} - c_{SD} u(t) dt \quad (1)$$

Settings

Previous studies categorized and defined the relationships among partners in the supply chain in different ways (Lummus and Vokurka 1999; Park et al. 2006; Mentzer et al. 2001; Mann et al. 2011). We adopt and apply three types of relationship, *full-cooperation*, *collaboration* and *non-cooperation*. In the full-cooperation setting, manufacturers share all information and resources of their supplier development programs with each other and pursue shared goal to maximize their profit.

Cooperative Supplier Development

In cooperative supplier development, manufacturers work or act together to achieve a common goal. In this scenario, manufacturers have an integrated profit. According to the mentioned factors of different settings, in the cooperative setting manufacturers follow a common goal, the same system model and simultaneous decision making.

Collaborative Supplier Development

In the collaboration setting, manufacturers seek to optimize their own goals and to gain more advantages from supplier development. They tend to share information about their investment with each other. The collaborative setting is broken down into two different settings, simultaneous and sequential decision making. Manufacturers may tend to make a decision with their partners at the same time (simultaneous), which causes to apply the same system model for both manufacturers. In sequential decision making, most probably the manufacturer who invests more make a decision about his/her investment first and lets the other one know about it. In this case, the second manufacturer can consider this information during his/her decision making.

Figure 2: General Scheme of MPC

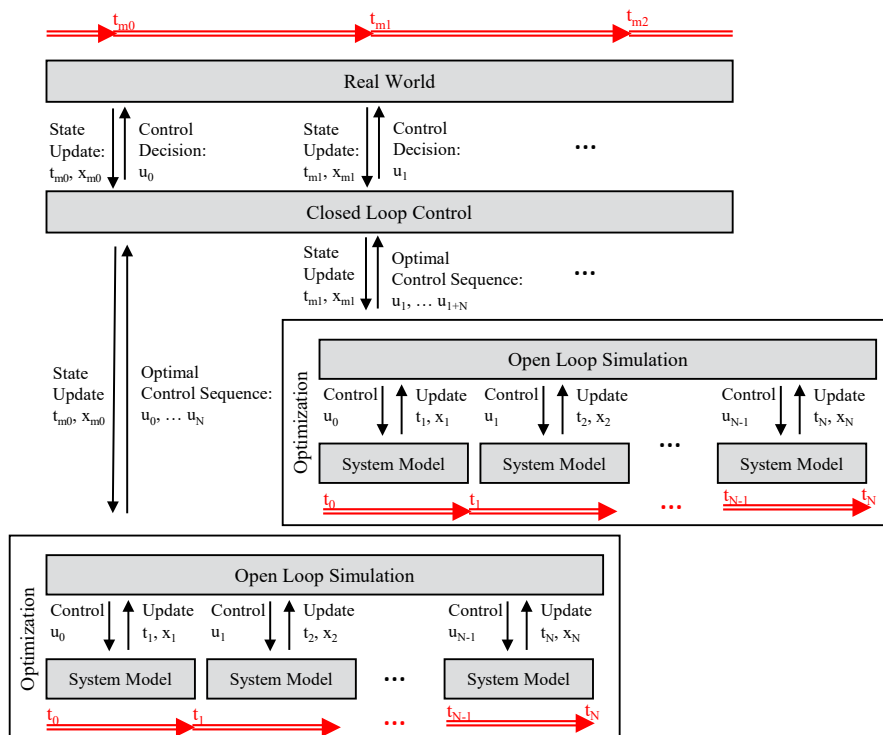

Non-Cooperative Supplier Development

In the non-cooperative setting, manufacturers look for their own goals and tend to not share any information about their supplier development program with each other. This setting mostly occurs in highly competitive markets. From the MPC point of view, both manufacturers have their own separate system models.

Numerical Simulation

In this section, we are particularly interested in the impact of manufacturers' relationships on their revenue on supplier development. To this end, we utilize the MPC method to find the optimal profit of supplier development. The values of parameters are shown in Table 1. Then we utilize these variables in Equation 1 to compute the corresponding output values of profit $J_T(u; x_0)$ and cost reduction $C_{0T}(x_0; t)$.

Regarding the different manufacturers' settings, we first compute the investment schema of M_1 and M_2 over time by using MPC. We observe that manufacturers in the fully cooperative setting tend to invest for longer periods than the others and the manufacturers experience faster and greater production cost reduction. In contrast to that, the non-cooperative scenario shows manufacturers look for shorter investment periods as the closed-loop feedback shows their investment is not paying off and they should stop investing in the development of the supplier. The collaboration result reveals that the bang bang behavior from Worthmann et al. (2016) and Proch et al. (2017) is not present in this setting, which may be due to manu-

Table 1: List of Parameters (Worthmann et al. 2016; Proch et al. 2017)

Symbol	Description	Value
T	Contract period	60(months)
m_2	Learning rate	-0:1
a	Prohibitive price	200
b	Price elasticity	0.01
c_{M1}	Variable cost per unit (M_1)	65
c_{M2}	Variable cost per unit (M_2)	70
c_0	Variable cost per unit (S)	100
c_{SD1}	Supplier development cost per unit M_1	9000
c_{SD2}	Supplier development cost per unit M_2	8500
u_1	Number of supplier development projects M_1	[0 5]
u_2	Number of supplier development projects M_2	[0 2]

facturers sharing information and receiving the feedback of the other one's investment, which encourages them to continue investing for longer periods even with the lower amount of investment. The collaboration results show that in the simultaneous scenario manufacturers invest in supplier for a longer period more than in the sequential one. Since MPC assumes a certain amount of profit, knowing that others also invest leads to higher profit expectations during the planning stage in this setting. To make the results clear, we compare the global profit (the sum of two manufacturers' profit) in each setting shown in Figure 3 (left), local profit (M_1 's and M_2 's profit) in Figure 3 (right). The result reveals that in earlier time steps non-cooperative behavior performs better and reaches faster to higher profits than the rest. However, for longer perspectives the fully cooperative setting shows the best performance and provides the highest profit for manufacturers. Consequently, for planning longer investments, cooperative behavior leads to the highest profit. However, for short

investments manufacturers should choose the non-cooperative setting to gain more profit from their investment.

Conclusion

In supplier development, one typically uses long-term contracts to control certain risks. We considered a receding horizon control scheme based on the much shorter but repeatedly prolonged horizons to analyze the risk of supplier development. Results show joint investments for longer periods pay off better in the long term. In shorter periods, an added value is generated as both the manufacturer and the supplier gain flexibility; then investing separately can result in higher profit for both manufacturers.

We expected to get higher pay off for the collaboration setting than a non-cooperative one, however, the results did not show any considerable difference for these two settings. As an instance in collaborative simultaneous setting, manufacturers tend to invest less on supplier development for longer horizon than the other partners. Since manufacturers share information

Figure 3: Global (left) and Local (right) Profit of Supplier Development of all Settings

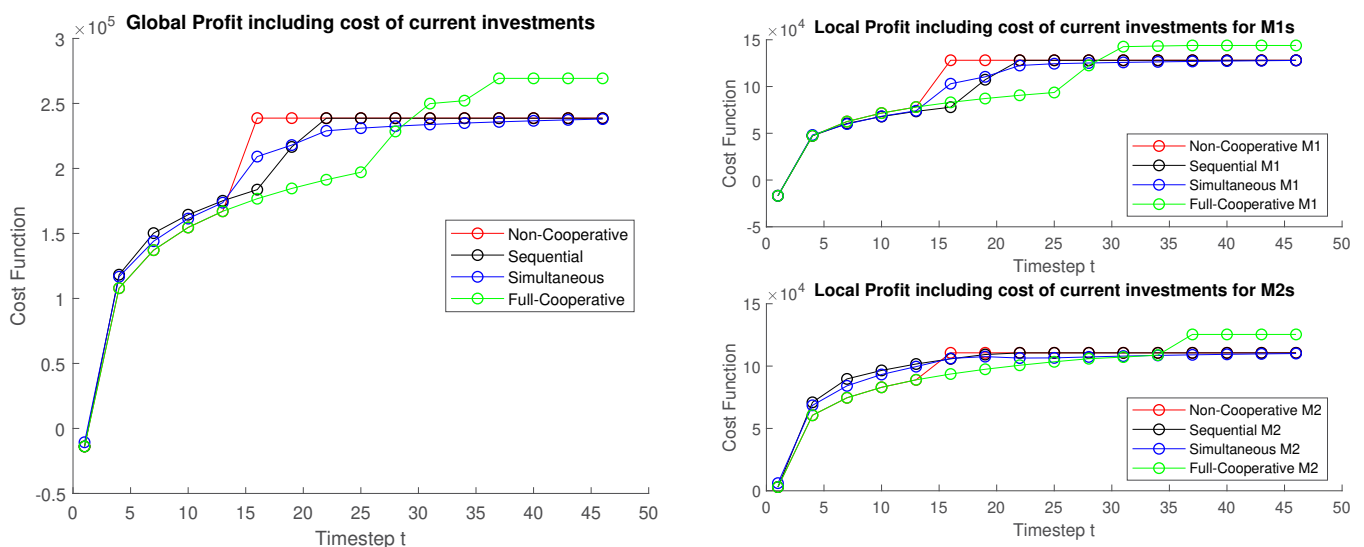

about supplier investment while they are looking for their own goals of supplier development.

References

- [1] Bai, C. and Sarkis, J. (2010). Green supplier development: Analytical evaluation using rough set theory. *Journal of Cleaner Production*, 18(12), pp. 1200–1210.
- [2] Bernstein, F. and Kok, G. (2009). Dynamic cost reduction through process improvement in assembly networks. *Manage Sci.*, 55(4), pp. 552–567.
- [3] Dyer, J. (1996). Does Governance Matter? Keiretsu Alliances and Asset Specificity as Sources of Japanese Competitive Advantage. *Organization Science*, 7, pp. 593–682.
- [4] Dyer, J. and Singh, H. (1998). The relational view: cooperative strategy and sources of inter-organizational competitive advantage. *Acad. Manag. Rev.*, 23(4), pp. 660–679.
- [5] Govindan, K., Kannan, D. and Haq, A. N. (2010). Analyzing supplier development criteria for an automobile industry. *Industrial Management & Data Systems*, 110(1), pp. 43–62.
- [6] Kim, B. (2000). Coordinating an innovation in supply chain management. *Eur. J. Oper. Res.*, 123(3), pp. 568–584.
- [7] Krause, D. R. (1999). The antecedents of buying firms' efforts to improve suppliers. *J. Oper. Manag.*, 17(2), pp. 205–224.
- [8] Krause, D. R. and Ellram, L. M. (2014). Supplier development investment strategies: a game theoretic evaluation. *Ann. Oper. Res.*, 240(2), pp. 583–615.
- [9] C9. Krause, D. R., Handueld, R. and Tyler, B. B. (2007). The relationships between supplier development, commitment, social capital accumulation and performance improvement. *J. Oper. Manag.*, 2(25), pp. 528–545.
- [10] Krause, D. R. and Scannell, T. (2002). Supplier development practices: product- and service-based industry comparisons. *J. Supply Chain Manag.*, 38(1), pp. 13–21.
- [11] Kruse, D. R. and Ellram, L. M. (1997). Success factors in supplier development. *International Journal of Physical Distribution and Logistics Management*, 27(1), pp. 39–52.
- [12] Li, H., Wang, Y., Yin, R., Kull, T. and Choi, T. (2012). Target pricing: demand-side versus supply-side approaches. *Int. J. Prod. Econ.*, 136(1), pp. 172–184.
- [13] Lummus, R. R. and Vokurka, R. J. (1999). Defining Supply Chain Management: A Historical Perspective and Practical Guidelines. *Industrial Management & Data Systems Journal*, 99(1), pp. 11–17.
- [14] Mann, H., Cao, Y. and Mann, I. J. (2011). Strategy Implementation Tools in Supply Chain Contracts. *IUP Journal of Business Strategy*, pp. 34–48.
- [15] Mentzer, J., DeWitt, W., Keebler, J., Min, S., Nix, N., Smith, C. and Zachsria, Z. (2001). Defining Supply Chain Management. *Journal of Business Logistics*, 22(2), pp. 1–25.
- [16] Park, M., Park, S. and Mele, F. (2006). Modeling of Purchase and Sales Contracts in Supply Chain Optimization. *Industrial & Engineering Chemistry Research*, 45(14), pp. 5013–5026.
- [17] Proch, M., Worthmann, K. and Schluchtermann, J. (2017). A negotiation-based algorithm to coordinate supplier development in decentralized supply chains. *European Journal of Operational Research*, 256, pp. 412–429.
- [18] Reed, F. and Walsh, K. (2002). Enhancing technological capacity through supplier development: A study of the UK aerospace industry. *Transactions on Engineering Management*, 49, pp. 231–242.
- [19] Routroy, S. and Pradhan, S. (2013). Evaluating the critical success factors of supplier development: a case study. *Benchmark Int. J.*, 20(3), pp. 322–341.
- [20] Sako, M. (1990). Prices, quality and trust: inter-firm relations in Britain & Japan. Cambridge, UK: Cambridge University Press.
- [21] Talluri, S., Narasimhan, R. and Chung, W. (2010). Manufacturer cooperation in supplier development under risk. *Eur. J. Oper. Res.*, 207(1), pp. 165–173.
- [22] Wagner, S. (2006). A firm's responses to deficient suppliers and competitive advantage. *J. Bus. Res.*, 59(6), pp. 686–695.
- [23] Wagner, S. (2011). Supplier development and the relationship life-cycle. *Int. J. Prod. Econ.*, 129(2), pp. 277–283.
- [24] Worthmann, K., Proch, M., Braun, P., Schluchtermann, J. and Pannek, J. (2016). Towards dynamic contract extension in supplier development. *Logist. Res.* 9, pp. 1–12.
- [25] Zajac, E. J. and Olsen, C. P. (1993). From transaction cost to transactional value analysis: implications for the study of inter-organizational strategies. *Journal of Management Studies*, 30, pp. 131–214.

*Co-Author

Jürgen Pannek



Haniyeh Dastyar, M.Sc.

Email: das@biba.uni-bremen.de
 Country: Iran
 Start: 01.10.2017
 Supervisor: Prof. Dr. Jürgen Pannek
 Faculty: Production Engineering
 Research Group: Dynamics in Logistics
 Funded by: Friedrich-Naumann-Stiftung für die Freiheit

Challenges with Technologies for Collaboration in Urban Logistics

We explore technical aspects and tools to investigate various roles of stakeholders who are involved in collaboration in urban logistics. A systematic literature review let us to 188 articles. We reviewed 25 articles related to the technical issues and found that simulation and optimization techniques were used to support the collaboration of different types of stakeholders. Data analysis technology is used to support partnerships. We identified a lack of research on educational aspects to support collaboration.



Introduction >>> Improving the quality of life, reducing the emissions of greenhouse gases as well as ensuring high service quality to all citizens have been predominant aims for research carried out during the last decade. This has induced the development of innovative transport and mobility solutions, both for passengers and goods (de Sousa & Mendes-Moreira, 2015; Maggi & Vallino, 2016). The main challenge is however that the success of the implementation and operation of these complex solutions requires a holistic and systematic approach taking all perspectives and stakeholders' needs into account on micro, meso and macro level (Weber, 2002). This requires a good understanding of the different stakeholders' activities and roles in urban logistics at various levels but also that these groups can develop a shared understanding that fosters their collaboration (Lindholm, 2012; Gammelgaard, 2015). The objective of this paper is to analyze available tools and supportive technologies fostering collaboration and shared understanding of the different stakeholder groups to understand the underlying mechanics better. The findings will be used for designing a new training tool. <<<

Research Methodology

This work is based on the previous systematic literature review presented in (Grudpan et al., 2017), using three databases: Scopus, Web of Science and IEEE, with the main keywords „urban logistics“ or „city logistics“ and filtering with 1. „challenge“, 2. „management“ and „technical involve-

ment“, 3. „management“ or „business“ and „economic“ and „engineering“ or „computer“ and „environment“, and 4. „stakeholder“. We then added „challenges“, which resulted in 174, 188, and 120 papers. Adding „stakeholder“ reduced the total number to 53. Only three articles were duplets, which resulted in 50 articles. Afterward, we extracted the information from the documents to analyze the challenges and the activities related to each role of the stakeholders as well as technical challenges in urban logistics.

Results

The analysis of the 50 papers showed challenges and activities of three different roles of stakeholders as well as the challenges related to technologies, tools and a simulation model for supporting collaboration activities in urban logistics.

Three Main Roles of Stakeholders

Local authorities / Public services: The main actors are the local authorities and the organizations that provide public services. These actors are generally interested in the sustainability of urban areas to assure good quality of life of the residents as well as fostering the economic activities. The implementation of these concepts requires collaboration between public and private stakeholders. Both of them have to be involved in the planning process. This leads to the development of technologies for simulating behaviors of stakeholders (carriers, logistics operators, residents, retailers and stores) to predict cause and effect of

policy and planning before implementing it in the real world.

Carriers / Logistics operators: The group of actors comprises of companies delivering goods and services in an urban area. Generally, some private carriers and producers provide logistics services. Their main activities are to distribute. The interest of private stakeholders is to make a profit and to increase service quality. These actors have to respond to the pressure from the regulations established by public stakeholders (limited delivery times, parking areas, transport emission control) and also to serve customer's satisfaction (residence and stores in the community) (Rose et al., 2016).

Receivers / Customers: Includes all actors receiving goods and services in a specific urban area. This can be residents, retailers, and/or stores. This type of stakeholders concerns the issues related to the negative environmental and societal impacts of emissions and congestions and how to reduce these issues by developing new concepts and solutions for an urban area.

Technologies and Tools for Supporting the Management of Mobility Data

Six papers are related to technology for the management of mobility data and information in urban logistics by sharing data and information as well as using the data for sustainable mobility. de Sousa & Mendes-Moreira (2015) increased sharing of network and transport resources can be achieved by designing and operating the

network in the way that each mode's performance improves. Giuli et al. (2013) stated that Mobility Information Services (MIS) in combination with ITS could reduce pollution, accidents rates, and congestions, and therefore improve the sustainability of mobility solutions. Mobility services require different sets of information to support people in pre-, on-, and post-trip situations. Consequently, MIS need to address requirements both from service users (front-end) and providers (back-end). This type of services involves all the three stakeholder groups identified above.

A Simulation Model

Simulation of logistics and transport networks for optimization have been deployed for decades (Gruler et al., 2016). However, besides the field of collaborative and participatory design approaches, most optimization models do not mirror the collaborative interaction between the stakeholders. Thus, they are not relevant for our purpose. Gruler et al. (2016) describe how simulation is used for the evaluation of complex city logistics systems and for predicting the effects of measures. According to Quintero-Araújo et al. (2016), agent-based modeling and simulation allows the consideration of the behavior of different stakeholders. Permala et al. (2015) mentioned that multi-modal transportation systems with electric vehicles (EVs) are used for the interaction of various stakeholders in connection to local traffic regulations, while simulation-based models are used for evaluating the behaviors of stakeholders regarding city logistics (Anand et al., 2016). According to Gruler et al. (2016), optimization for establishing efficient location-, routing-, and scheduling plan behavioral factors of individuals and their interactions are only scarcely considered due to the uncertainty in traditional optimization models. Combining simulation and optimization would overcome the drawback.

Conclusion

We found that each type of stakeholder has individual challenges. This leads to a different use of technologies and tools for supporting them to provide solutions for the different aspects. Additionally, we noticed a lack of research on educational aspects to support for the necessary collaboration. Notably, research that supports stakeholders to have more understanding of their tasks and roles is missed. Hence, in the next steps, we are going to look for available tools or mechanisms that are used to support collaboration and common understanding of people with different perspectives. The findings of the described analysis are roles and tasks of stakeholders that can be used for designing a new training tool (game) to increase the stakeholder's involvement in the urban activities.

References

- [1] Anand, N., Meijer, D., van Duin, J. H. R., Tavasszy, L. and Meijer, S. (2016). A participatory simulation gaming framework for the validation of an agent-based model: the case of city logistics (No. 16-7032). <https://trid.trb.org/view/1394579>.
- [2] de Sousa, J. F. and Mendes-Moreira, J. (2015). Urban Logistics Integrated in a Multi-modal Mobility System. *Intelligent Transportation Systems (ITSC), 18th International Conference IEEE*, pp. 89-94.
- [3] Gammelgaard, B. (2015). The emergence of city logistics: the case of Copenhagen's City-logistik-kbh. *International Journal of Physical Distribution & Logistics Management*, 45(4), pp. 333-351.
- [4] Giuli, D., Paganelli, F., Cuomo, S. and Cianchi, P. (2013). Toward a cooperative approach for continuous innovation of mobility information services. *IEEE Systems Journal*, 7(4), pp. 669-680.
- [5] Grudpan, S., Baalsrud Hauge, J. and Thoben, K. D. (2017). A systematic literature review of challenges in urban logistics. *22nd International Symposium on Logistics ISL*, pp. 227-231.
- [6] Gruler, A., de Armas, J. and Juan, A. A. (2016). Behavioral Factors in City Logistics from an Operations Research Perspective. *International Conference on Smart Cities*, Springer Cham, pp. 32-41
- [7] Lindholm, M. (2012). Enabling sustainable development of urban freight from a local authority perspective. *Chalmers University of Technology*, <https://doi.org/10.1016/j.trc.2016.08.002>
- [8] Maggi, E. and Vallino, E. (2016). Understanding urban mobility and the impact of public policies: The role of the agent-based models. *Research in Transportation Economics*, 55, pp. 50-59.
- [9] Permala, A., Rantasila, K., Porthin, M., Hinkka, V., Eckhardt, J. and Leonardi, J. (2015). Multi-criteria evaluation method for freight logistics innovations. *IET Intelligent Transport Systems*, 9(6), pp. 662-669.
- [10] Quintero-Araújo, C. L., Juan, A. A., Montoya-Torres, J. R. and Muñoz-Villamizar, A. (2016). A simheuristic algorithm for horizontal cooperation in urban distribution: application to a case study in Colombia. *Proceedings of the 2016 Winter Simulation Conference*, IEEE Press, pp. 2193-2204.
- [11] Rose, W. J., Mollenkopf, D. A., Autri, C. W. and Bell, J. E. (2016). Exploring urban institutional pressures on logistics service providers. *International Journal of Physical Distribution & Logistics Management*, 46(2), pp. 153-176.
- [12] Vlacheas, P., Giaffreda, R., Stavroulaki, V., Kelaidonis, D., Foteinos, V., Poullos, G. and Moessner, K. (2013). Enabling smart cities through a cognitive management framework for the internet of things. *IEEE communications magazine*, 51(6), pp. 102-111.
- [13] Weber, M. (2002). *Wirtschaft und Gesellschaft: Grundriss der verstehenden Soziologie*. Mohr Siebeck.

*Co-Authors

Jannicke Baalsrud Hauge
Klaus-Dieter Thoben



Supara Grudpan, M.Sc.

Email: gud@biba.uni-bremen.de
Country: Thailand
Start: 01.08.2016
Supervisor: Prof. Dr. Rainer Malaka, Ass. Prof. Dr. Baalsrud-Hauge
Faculty: Mathematics / Computer Science
Research Group: Digital Media
Funded by: ERASMUS MUNDUS project FUSION and Chiang Mai University

Sustainable Inner-Urban Intermodal Transportation in Retail/Post

The retail/postal industry is intent on finding appropriate internal approaches to respond to the adverse impacts generated by urban freight activities. Usage of emerging transport modes is an efficient solution. Nevertheless, considerable research has paid less attention to the implementation status of distribution innovations (DIs), and to their operation together as a system. We applied a systematical literature review and a GE Multifactorial Analysis to discuss the application status of DIs, their suitability and their restrictions. As a result, we propose the concept of sustainable inner-urban intermodal transportation.

Introduction >>> Commodity demand growth and consumer behavior changes have continually increased the frequency of freight activities within urban areas. Moreover, urban freight activities also cause air pollution, congestion, noise, etc. [1][2]. These environmental externalities have fundamentally required the retail and postal industries to choose more suitable transport modes and operational strategies for the various segments of urban freight transport. To this end, logistics providers and technology companies proposed several innovative transport modes/concepts. However, much less research has paid attention to the application status of DIs and their suitability assessment. Besides, comprehensive consideration of operational strategies and risk evaluations, particularly on various DIs that operate together as a system, is lacking. Therefore, we propose sustainable inner-urban intermodal transportation (SIUIT). <<<

Application Status of DIs

Urban DIs refer to transportation enterprises which apply the emerging urban transport mobility to the transship/delivery of goods within urban areas and are intended to reduce the negative impacts created by freight movements and provide the diversification of logistics services. According to a systematical review of papers that were published in 2013-2018, we determined 11 emerging transport modes:

Electric vehicles, modular E-vehicles, cargo bikes, delivery drones, public transit system, robotic vehicles, taxi logistics, urban waterway logistics, parcel lockers, mobile depots, delivery robot. Following the systematical literature review (SLR), considerable research has paid less attention to the application status of DIs.

GE Multifactorial Analysis consists of two dimensions used to evaluate the existing portfolios of strategic business units. Each dimension is classified into three levels to create the two-dimensional GE matrix. First, we defined the two dimensions of the *academic research* and the *company implementation* phase. Following a review of the related articles, we classified each dimension into three phases (Figure 1).

Figure 1: GE matrix of the analysis

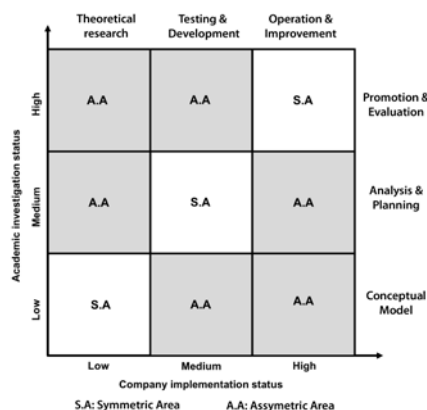

According to the review of research reports, case studies in the articles, and official websites of enterprises, we systematically analyzed the application status of these innovations.

Figure 2: Technology implementation status

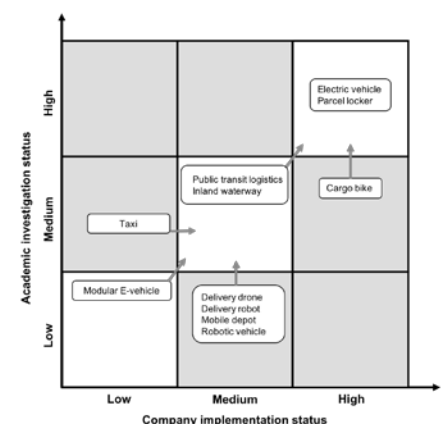

Figure 2 demonstrates the *implementation status of DIs* based on the previous GE matrix. Currently, modular E-vehicles are still at the low-low phase. Electric vehicles and parcel lockers have been at the high-high level of application. Academia and companies have paid more attention to them as replacement policies and promotion strategies within urban areas. In contrast, delivery drones, delivery robots, mobile depots, and robotic vehicles have so far still maintained a medium-low level of application. The costs and external elements (e.g., wea-

ther, vandalism) have radically restricted their wide application in enterprises.

Moreover, taxi delivery is at the low-medium level, where immature technology and local transport policies are the primary barriers for applying these in urban freight transport. It is noted that public transit systems and inland waterway transportation are at the level of medium-medium. This observation implies that the integrated freight and passenger model in urban freight transport has increasingly become the future operational measure in city logistics. This notwithstanding, enterprises still need to promote the implementation phase of these emerging technologies to the next level actively, while academic research has to consider the relevant elements comprehensively to evaluate risks and make the operational measures and policies for local authorities and private companies. In addition, applying cargo bikes to the delivery of goods has received more attention in recent years. However, academic research is still in the analysis and planning phase. The future research direction of innovative cargo bikes is in the promotion and evaluation phase. In summary, the various DIs are in different implementation phases. These innovative units have formed the new urban intermodal transportation concept, which is a necessary consideration in the future agenda of urban freight planning.

Concept of SIUIT

Some companies have operated one or two DIs together as a system. Following the previous analysis, we determined that some city logistics providers and technology enterprises have launched new concepts of integrated operation among these technologies, while they have begun to test them in the real world. Lots of operating modes have applied the standardized box/container

Figure 3: The concept of sustainable inner-urban intermodal transportation (SIUIT)

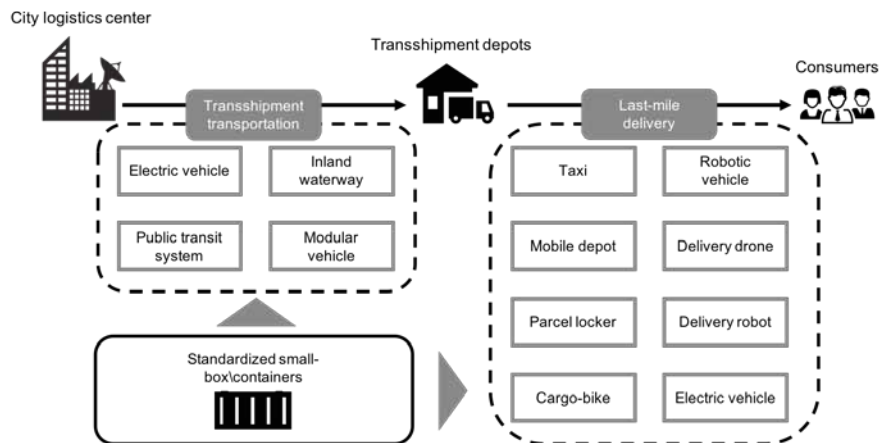

(the capacity is approximately 1–2 m³) (e.g. [3],[4]). However, there is still a lack of a systematic analysis of the current status of the integration of DIs. Therefore, we propose the concept SIUIT (Figure 3). It is defined as the combined use of various emerging transport modes (e.g., tram, bus, cargo bike) to transport goods by small modular containers from a city's logistics center to a consumer.

The integration of the various DIs is a challenge for urban freight transport. This includes the special infrastructure construction, structure changes of the urban freight network, software platform establishment, as well as the formulation of urban freight policy and laws, etc. Meanwhile, considerable research has paid less attention to links between city development and the integration of urban freight distribution. Hence, further research of SIUIT also needs to consider the future trends of urban development comprehensively. In addition, the selection and integration between the distinct innovations produce the different operational scheme of SIUIT. Which type of SIUIT is suitable for the different city environments needs to be further investigated.

References

- [1] Anderson, S., Allen, J. and Browne, M. (2005). Urban logistics - How can it meet policy makers' sustainability objectives? *Journal of Transport Geography* 13(1), p. 71. DOI: 10.1016/j.jtrangeo.2004.11.002
- [2] Wittlöv, A. (2012). *Urban freight transport: Challenges and opportunities, Urban freight for livable cities. How to Deal with Collaboration and Trade-offs*, pp. 12–23. http://www.vref.se/download/18.11165b2c13cf48416de7e59/FUT-Urban-Freigh-Webb_low.pdf seen on June 6, 2019
- [3] Behiri, W., Ozturk, O., Belmokhtar-Berraf, S. (2016). *Urban Freight by Rail: A MILP Modeling for Optimizing the Transport of Goods*, pp. 2–9. http://ils2016conference.com/wp-content/uploads/2015/03/ILS2016_SC01_2.pdf, seen on June 6, 2019
- [4] Masson, R., Trentini, A., Lehuédé, F., Malhéné, N., Péton, O. and Tlahig, H. (2017). *Optimization of a city logistics transportation system with mixed passengers and goods*, *EURO J. Transp. Logist.*, 6(1), pp. 81–109.

*Co-Author

Hans-Dietrich Haasis

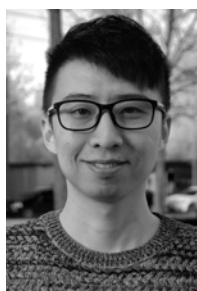

Zhangyuan He, M.Sc.

Email: zhe@uni-bremen.de
 Country: China
 Start: 01.10.2016
 Supervisor: Prof. Dr. Dr. h.c. Hans-Dietrich Haasis
 Faculty: Business Studies / Economics
 Research Group: Business Administration, Maritime Business and Logistics
 Funded by: China Scholarship Council (CSC)

A Multi-Agent System for Truck Dispatching in Open-pit Mines

Material handling is a major logistic process for open-pit mines. Several centralized methods have been employed to support this process. However, they don't provide precise solutions due to the use of estimated information from equipment items and don't react appropriately when a significant changes occur in the process. To tackle this problem, we developed a multi-agent system (MAS) where the equipment items are represented by intelligent agents which use a Contract Net Protocol with confirmation stage to create a more precise solution. We evaluated the solutions of the MAS using historical data from a Chilean open-pit mine.



Introduction >>> Material handling is an important process for open-pit mining since it can amount to up to 50% of the cost (Alarie and Gamache, 2002). In this process, shovels extract materials and load trucks that transport these materials to different destinations. If the extracted material is waste, it is transported to a waste dump; otherwise, it is transported to a crusher or a stockpile. This process has to be performed in a dynamic environment that may affect the availability and performance of the equipment.

Current centralized solutions do not provide precise results due to the use of estimated information, and the time needed to obtain a solution. In this paper, we present a solution based on multi-agent systems. Here, the equipment items are represented by intelligent agents that interact with each other to meet the production goals at a minimum cost. This approach allows us to model the truck dispatching in a way that is closer to reality and thus to avoid the weaknesses of centralized solutions. <<<

Problem Statement

The current systems for truck dispatching in open-pit mines follow a centralized approach based on methods from Operations Research or on heuristic procedures. Due to the complexity of the process and the dynamics of the environment, the systems use estimated data to provide a rough solution

for an equipment schedule in a practical time frame. For instance, most of them determine the number of trips to transport the required material in the production plan from a loading point to an unloading point. Then, after a truck finalizes an unloading assignment (an assignment is a set of related operations), it requires a new destination for loading. The systems provide a new loading point by considering some criteria, such as the distance to the loading point or the loading point with the least production, among others.

Using a rough solution does not enable an efficient operation of the machines (Paterson, Kozan and Hyland, 2017). Even when there are some trucks available for a loading assignment and the system selects the best choice, this selection will be a local maximum. Alternatively, a more precise solution that would allow the machines to operate more efficiently would be schedules for each machine with all the operations that the machines must do, pointing out the start times, end times, etc.

Solution Approach

A multi-agent system is a system compound of agents that are intelligent software programs that virtually represent an entity and/or provide a certain service (Gath, 2015). The MAS implemented for the truck dispatching in open-pit mines is composed of several agents that interact with each other in a cooperative environ-

ment to achieve a common objective: to accomplish the goals of the production plan at the minimum cost. To do this, the agents create schedules of the operations of the machines, considering their different objectives.

In the beginning, the agents create preliminary schedules using their specific data. Then, the agents start a refinement stage to improve their schedules. The agents implemented in the MAS include the following:

Truck agent is a simple reflex agent because its acts only are based on the current percept. The main specific data are capacity, loaded velocity, empty velocity, spotting time and unloading time. It only interacts with the TruckPlanner agent when the latter requests information. Every truck in the real world is represented by a truck agent. *Shovel agent* is a simple reflex agent. The main specific data are capacity, dig velocity, load velocity and destination of extracted material. It only interacts with the ShovelPlanner agent when the latter requests information. Every shovel or front loader in the real world is represented by a shovel agent.

UnloadingPoint agent is a simple reflex agent. The main specific data is the number of trucks unloading simultaneously. It only interacts with the UnloadingPlanner agent when the latter requests some information. Every unloading point (crusher, stockpile or waste dump) in the real world is represen-

ted by an UnloadingPoint agent. *ShovelPlanner agent* is a utility-based agent because it can make decisions based on a utility function. Its objective is to create a schedule of the operations of the machine that it is related to, taking into account the maximization of the production and the minimization of the idle time. To create the schedule, the agent interacts with other agents. A piece of specific information used by this agent is the operational goal of the machine that it is related to in the production plan. Each loading machine in the real world is represented by a ShovelPlanner agent. *TruckPlanner agent* is a utility-based agent. Its objective is to create a schedule of the operations of the truck that it is related to at a minimum cost. To create the schedule, the agent interacts with other agents. One of the most important pieces of information is the layout of the mine. Each truck in the real world is represented by a Truck-Planner agent.

UnloadingPlanner Agent is a simple reflex agent that registers the scheduled truck unloadings. It interacts with a TruckPlanner agent when the latter requires a waiting time. *Initiator agent* initiates a negotiation when another agent requests it. *Participant agent* takes part in a negotiation process initiated by an initiator agent. To create the schedules, the agents must interact with each other using the Contract Net Protocol (CNP) (Smith, 1980) which is a well-known negotiation mechanism for task sharing. In this context, the CNP works as follows: a ShovelPlanner agent requires an initiator agent to start a negotiation process. It sends it the time when the shovel is available to load a truck. With this information, the initiator agent initiates a negotiation process by sending a call for proposals (CFP) to the participant agents that are related to trucks. When a participant agent receives the CFP, it must send it to the cor-

responding TruckPlanner agent to evaluate the CFP. The TruckPlanner agent checks its schedule and asks for information to the unloadingPlanner agent about waiting time. With this information, the TruckPlanner agent calculates the arrival time and the cost to arrive at the shovel. The Truck-Planner agent can decide to reject the proposal. It sends its decision to the participant agent. The participant agent prepares the proposal and sends it to the initiator agent. If the proposal was not rejected by the TruckPlanner agent, the participant agent waits for the answer from the Initiator agent. The Initiator agent receives the proposals and looks for the proposal that proposes the arrival time with the least waiting time to the shovel. If there are several proposals with the same arrival time, the Initiator agent selects the proposal with the least cost to arrive at the shovel. Then, the Initiator agent sends an acceptance message to the participant agent that proposed the best proposal, sends a rejection mes-

Figure 1: The interaction between the agents using the CNP with the confirmation stage

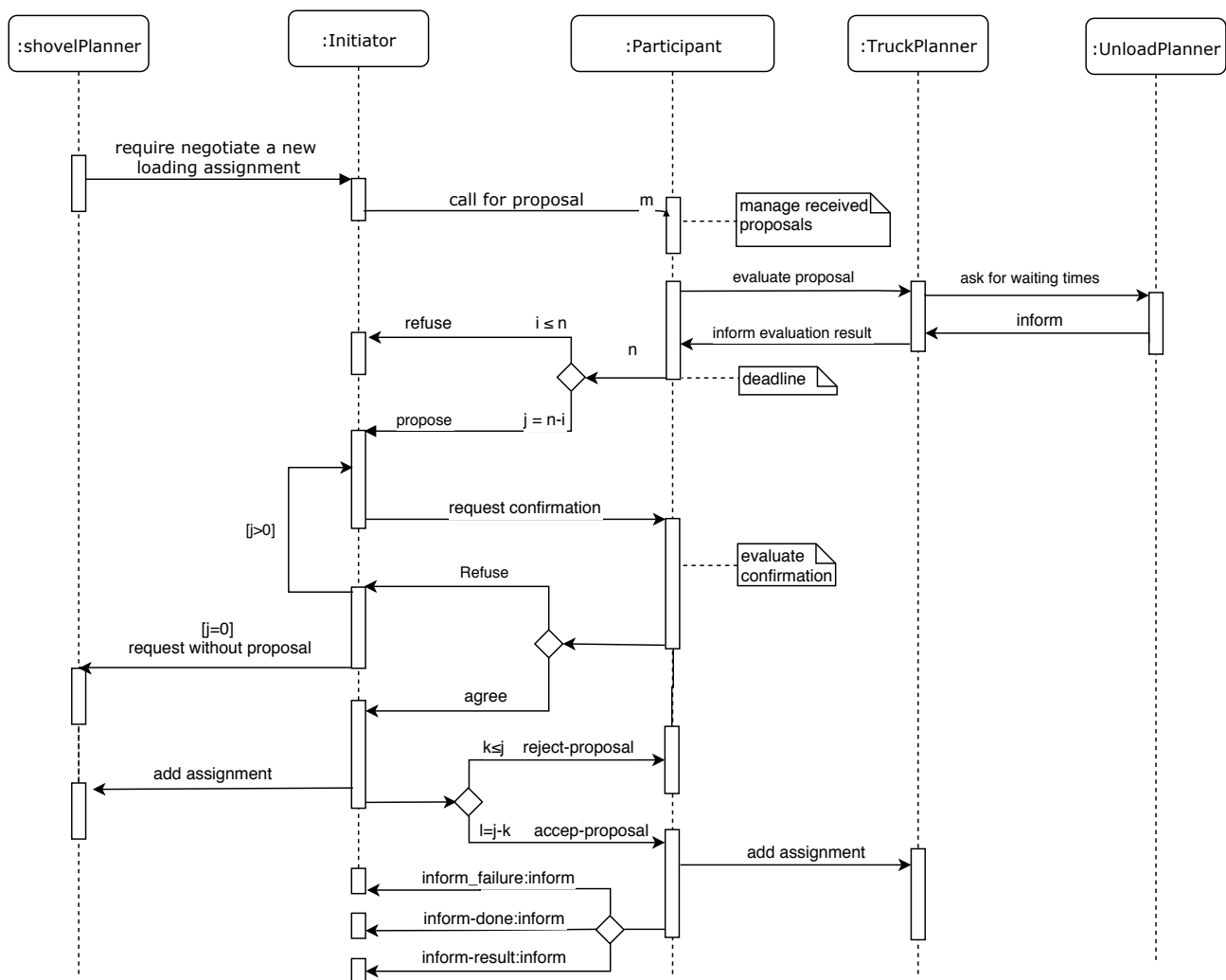

Table 1: Example of a schedule for a truck created by the MAS

Assignment	Destination	Estimated Start Time Of The Trip	Estimated Arrival Time	Estimated Start Of Spotting	Estimated Start Time Of Loading-Unloading	Estimated End Time Of Assignment
0	Shovel.01	00:47:01	01:20:23	01:20:23	01:21:36	01:23:12
1	WasteDump.02	01:23:12	01:32:33	01:32:33	01:32:33	01:33:23
2	Shovel.04	02:10:39	02:18:47	02:18:47	02:20:00	02:21:12
3	WasteDump.03	02:21:12	02:26:38	02:26:38	02:26:38	02:27:28
4	Shovel.04	02:27:28	02:31:37	02:31:37	02:32:50	02:34:02
5	WasteDump.03	02:34:02	02:39:28	02:39:55	02:39:55	02:40:45
6	Shovel.04	02:40:54	02:45:03	02:45:03	02:46:16	02:47:28
7	WasteDump.03	02:47:28	02:52:54	02:52:59	02:52:59	02:53:49

sage to the other Participant agents, and informs the ShovelPlanner agent of the winning proposal. The Participant agent that receives the acceptance of its proposal informs the TruckPlanner agent that the proposal was accepted, and the TruckPlanner agent adds the new assignment to its schedule. The ShovelPlanner agent that receives the information of the winning proposal adds it to its schedule. If the Initiator agent does not receive proposals, it informs the ShovelPlanner agent that the negotiation is finished without proposals.

Due to the agents work in parallel, several negotiations using the CNP are made concurrently. As a consequence of this, a Participant agent receives several CFPs. If the Participant agent sends a proposal to one of this CFPs, it must wait for the answer from the ShovelPlanner agent. Therefore the other CFPs received are rejected. This situation can generate that the Participant agent rejects a CFP that is a better option than the CFP previously answered. This problem is also called „the eager bidder problem“ (Schillo, Kray and Fischer, 2002). To avoid this problem, a confirmation stage (Knabe, Schillo and Fischer, 2002) is included in the CNP that works as follows: when the Initiator agent finalizes the evaluation

of the proposals, it sends a confirmation message to the Participant agent with the best proposal. The Participant agent that receives the confirmation message could reject the confirmation (in the case that it has received a better CFP; otherwise, it can accept the confirmation). If the Participant agent sends a rejection of the confirmation to the Initiator agent, the Initiator agent sends a confirmation message to the next best proposal received. On this way, the confirmation stage allows the Participant agent to decommit a previous proposal sent. Figure 1 depicts the interaction between the agents using the CNP with the confirmation stage. Table 1 shows a schedule created by the MAS.

After creating the schedules, the agents start a refinement stage. In this stage, the agents look for improvements through two actions:

Shovel loadings: The objective is to increase the production of a loading entity. If a ShovelPlanner agent has idle time between loadings in its schedule, the agent requires an initiator agent to start a negotiation process offering its idle time slots.

Truck-assignment transfers: The objective is to decrease transport cost. The idea is as follows: If truck A can do an assignment of

truck B with less time than truck B, without affecting its schedule, the assignment must be deleted from the schedule of truck B and transferred to truck A. Here, a TruckPlanner agent requires an Initiator agent to generate a negotiation process offering an assignment. Due to the agents work in parallel several negotiation processes are running simultaneously. As a consequence, a TruckPlanner agent which asked an Initiator agent to start a negotiation process could receive a CFP to evaluate from a negotiation process started by another TruckPlanner agent. In this case, the agent must avoid using an assignment in more than one negotiation process. Otherwise, a consistency problem will arise.

Evaluation

To demonstrate the validity of the proposed solution, and to validate its practical use, an evaluation with historical data from an open-pit copper mine in Chile was done. The properties of the agents such as the loaded velocity of the trucks and the dig velocity of the shovels were set from the historical data. The equipment items are operated in shifts of 12 hours. The implemented MAS was deployed and executed in PlaSMA (Warden et al., 2007), which is a

Table 2: Performance metrics of the MAS for different size problems of open-pit mines

Inst.	H	Shovels	Trucks	Material to Transport (tons)	Duration Travels (hours)	Time to generate the schedules (min)
1	1	1	10	6,292	72.62	0.04
2	3	3	25	40,249	72.62	0.43
3	6	5	40	136,136	221.39	2.45
4	9	7	60	316,689	474.04	4.52
5	12	9	85	558,587	880.15	16.74

simulation platform for multiple agents. Table 2 shows different size problems (H: length of the time horizon of the shift; the number of shovels; the number of trucks) and the performance results of the MAS in terms of material transport scheduled, needed time to transport the material, and the time that the MAS takes to get the schedules. The MAS needed around 16 minutes to generate the schedules for all machines of the biggest problem, which is a reasonable time.

Conclusion and Outlook

A MAS for truck dispatching in open-pit mines has been presented. Experimental results show that it provides a more precise solution than the current centralized solutions in a practical time frame. Future investigations will include the dynamics aspect of the material handling process. This means that when a significant change occurs such as machine failures or changes in the mine layout, the affected agents will have to react appropriately, interacting with each other to update their schedules. Also, a comparison against a centralized method will be made.

References

- [1] Alarie, S. and Gamache, M. (2002). Overview of Solution Strategies Used in Truck Dispatching Systems for Open Pit Mines. *International Journal of Surface Mining, Reclamation and Environment*, 16(1), pp. 59–76.
- [2] Gath, M. (2016). *Optimizing Transport Logistics Processes with Multiagent-based Planning and Control*. Springer Vieweg.
- [3] Knabe, T., Schillo, M. and Fischer, K. (2002). Improvements to the FIPA Contract Net Protocol for Performance Increase and Cascading Applications. *International Workshop for Multi-Agent Interoperability at the German Conference on AI (KI-2002)*
- [4] Patterson, S. R., Kozan, E. and Hyland, P. (2017). Energy efficient scheduling of open-pit coal mine trucks'. *European Journal of Operational Research*, 262(2), pp. 759–770.
- [5] Schillo, M., Kray, C. and Fischer, K. (2002). The eager bidder problem: a fundamental problem of DAI and selected solutions. *Proceedings of the 1st international Joint Conference on Autonomous Agents and Multiagent Systems (AAMAS'02), part 2, July*, pp. 599–606.
- [6] Smith, R. G. (1980). The Contract Net Protocol: High-level communication and control in a distributed problem solver. *IEEE Transactions on Computers*, C-29(12), pp. 1104–1113.
- [7] Warden, T., Porzel, R., Gehrke, J. D., Herzog, O., Langer, H. and Malaka, R. (2007). Towards Ontology-Based Multiagent Simulations: Plasma Approach. https://www.academia.edu/15635600/Towards_Ontology-Based_Multiagent_Simulations_The_Plasma_Approach seen on June 6, 2019

*Co-Authors

Raúl Zuñiga
Otthein Herzog



Gabriel Icarte, M.I.T.

Email: gicarte@uni-bremen.de
Country: Chile
Start: 01.10.2016
Supervisor: Prof. Dr. Otthein Herzog
Faculty: Mathematics / Computer Science
Research Group: TZI Center for Computing and Communication Technologies
Funded by: BECAS Chile / DAAD

Exploring Contextual Information in Manufacturing and Logistics Processes

The important characteristics of manufacturing and logistics business processes are a high degree of flexibility and complexity. These characteristics are driven by process evolution and unexpected changes. As a consequence, improving business processes requires insight knowledge of the process behaviors. The context information generated from event data during automated process model creation can be used to discover the conditions that impact the processes. We focus on the context impacting the process lead time. Naïve Bayesian is used for context reasoning to discover and analyze the relationship between a particular process and its context information. We illustrate our approach with real-world event logs from manufacturing companies.

Introduction >>> Data analysis in business process improvement becomes extremely important to manufacturing and logistics systems. The objective of data analysis is to discover new knowledge for solving problems and optimizing processes to create core competencies. One of the potential technique to perform data analysis in business process improvement is the process mining approach. The significant advantage of the approach is its ability to discover how processes are executed in the real world by extracting knowledge from event logs [1]. The event logs come from various sources such as information systems, software, and applications.

The objective of our study is to extend the application of process mining in order to analyze processes in the dynamic environment of manufacturing and logistics. Such dynamic environment, regular processes are still accompanied by relevant context information. Therefore, we apply relevant context information in process mining to extract more insights from event data. Analysis contextual information assists indicating the process variants and the need for process changing as well as facilitate learning from the past to support decision making. We focus on the methodology to capture the relevant context information that affects the business process performance. We use process lead time as Key Per-

formance Indicators (KPI). We select two types of contextual information to analyze and infer the influence to process lead time: (1) the number of process activities/events which compete for the same resources, and (2) the process lead time of the previous order whether it was delayed. These two contexts are derived from real event logs from three different companies. Naïve Bayesian (NB), arithmetic mean and standard deviation are applied for context reasoning. <<<

Contextual Information in Business Processes

The context which is associated with business processes can be categorized into four types:

Instance context refers to the context that influences the execution of the process instance. For example, the size of the order can change the type of transportation or expand process lead time to be longer. However, only considering the instance context might not be enough to analyze and understand the behavior of the business processes.

Process context refers to the contextual information that affects the execution of several processes. For example, many process instances might require the same resource in the same period of time, which lead to a delay of the orders.

Wacharawan Intayoad*



Social context refers to the factor of how people work together. The social context is also crucial, particularly in the processes that require human works. For example, the conflict between individuals might cause a delay of the process instance.

External context refers to the contextual information that is beyond the control of any organization such as weather, economic, government policies and etc.

We concentrate the research on the first two types, instance context and process context, which can be extracted from event data. The analysis is focused on the relevant context information that particularly influences the lead time of business processes.

Research Methodology

The goal of this work is to extract knowledge of relevant context information from actual event logs. Event logs are tables or databases which contain records about sequences of events and their properties. Each event refers to an activity which is related to a particular process instance or a case. It includes an originator (i.e., the machine executing the activity), and a timestamp of the event. In order to explain our approach, the types of inputs required in our approach need to be clarified.

An event represents an activity in the process instance. Let E be all possible events, and e be any event in E . An event e is characterized by various properties. In this study, e is characterized as the originator, and a timestamp corresponding to start time and end time of the event e . To give the focus of this study, we assume that a machine ID identifies the specific originator.

An example of event logs is presented in Table 1. Each row of the table represents a single event. Order ID is the identity of one process instance or a case. And a machine ID refers to the originator performing the activity which is associated with one particular case. For example, order ID 1 is composed of two events e_1 and e_2 , where machine ID 1 and 2 are the originators of e_1 and e_2 , respectively. The start time and end time of e_1 are 18-02-16 07:20:45 and 18-02-16 08:12:10, respectively. Order ID 1 and order ID 3 have a common originator (machine ID 1), which can be interpreted that both orders executed a similar activity and used the same resource.

Our approach focuses on finding the relationship between process context and business performance. The process contexts are (1) the lead time of the latest completed process instance and (2) the number of competing activities. The business performance refers to lead time of a process instance. For example, if the lead time of the previously completed process instance is delayed, the focused one might be delayed as well. Or if there are many competing activities, the lead time of the focused process might be delayed as well. Fig. 1 depicts the proposed approach.

Grouping Similar Processes and Calculating Process Lead Time

Real event logs are often unlabeled, which means that there is no identity to group similar process instances. However, similar process instances have to be grouped because we have to determine the average process lead time. In this way, it makes it possible to analyze the relationship between process lead time and relevant context information. After grouping similar in-

stances processes, we need to find a lead time for every process instance. The output of this step is the list of the lead time of every activity/event in the same group.

Finding a Number of Competing Events

The objective of this step is to find a number of competing events for every process instance in the same period of execution time. Competing event refers to the set of events that compete to use the same resources of the target process instance in the same period of execution time.

Figure 1: Proposed research approach

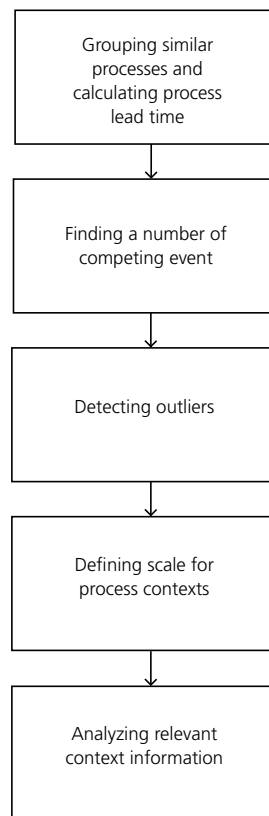

Detecting Outliers

The outlier means the data objects which do not comply with a general model of data [3]. Outliers may lead to incorrect analysis and interpretation. Thereby, in this process, the outliers are detected and eliminated.

In order to detect outlier, we use the interquartiles (IQRs) to find the outliers

from the datasets. IQRs general idea is to divide data at 25% (Q1), and at 75% (Q3), then the interquartile range $IQRs=Q1-Q3$. Every data point, which is out of the range between $Q1-1.5IQRs$ and $Q3+1.5IQRs$ are considered as the outliers [4]. Noted that the outlier will be integrated when we perform the classification.

Defining Scale for Process Contexts

In the second step, we have to define the scales to measure the difference between the lead time and the number of competing events. We assume that these two variables are independent of each other. Then, we use the arithmetic mean (m) and standard deviation (SD) to calculate the range scale of process contexts. We determine the lead time as a delay, if the lead time is more than $m + SD$.

For the number of competing events, it is divided into three groups, low, average, and high, to range the amount of the competing events. The number of competing events is defined as low when the number of activities is less than $m - SD$. It is defined as average when the number of activities is between $m \pm SD$. And it is defined as high when the number of activities is more than $m + SD$.

Analyzing relevant context information This step adopts Naive Bayesian (NB) for analyzing the relationship between process behavior and relevant context information. NB is used as context reasoning for deducing new knowledge, and better understanding based on the available context from event logs. The NB is supervised learning from a probabilistic point of view. It is an independent assumption between predictors. This study selects the NB for probabilistic logic to combine pieces of evidence and to handle unseen situations. NB is applicable for large datasets, easy to understand, well performing in most cases, and easy to update as new data is added. Equation (1) is the NB.

$$P(C_i|X) = \frac{P(X|C_i)P(C_i)}{P(X)} \quad (1)$$

Let D be a training set of tuples associated with the class label. Each tuple is an n -dimensional attribute $X=(x_1, x_2, \dots, x_n)$. C is the set of classes and m is the number of classes, $C_1, C_2, C_3, \dots, C_m$. Let $P(C_i|X)$ be the posterior probability of target class given a predictor. The classifier will predict X belonging to the class having the maximum posterior probability [5].

Table 1: Fragment of an event log

Order ID	Machine ID	Start Time	End Time
1	1	18-02-16 07:20:45	18-02-16 08:12:10
1	2	18-02-16 13:32:16	19-02-16 10:11:01
2	2	21-01-16 19:51:15	24-01-16 10:07:43
2	4	24-01-16 10:07:43	30-01-16 11:00:16
3	1	24-02-16 07:46:11	28-02-16 13:53:32
3	2	28-02-16 13:53:32	28-02-16 18:40:22

Figure 2: Structure of the naive Bayesian classifier

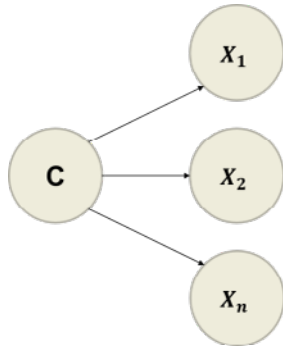

Fig. 2 presents the conditions probabilities with arrows between variables. A class C is related to features variables X_1, \dots, X_n representing condition probabilities $P(X_i | C)$. Equation 2 represents the joint probability density function network [6].

$$P(C|X_1, \dots, X_n) = P(C) \prod P(X_i|C) \quad (2)$$

Solving the joint probability density function gives the probability for discrete class variable C to be in state j.

Result

The three real-world event logs are deployed in this study as dataset A, B, and C. These datasets come from three different manufacturing companies. Dataset A contains 120 cases which are determined as 39 delayed lead time processes and 81 undelayed lead time processes. Dataset B contains 721 cases which are determined as 180 delayed lead time processes and 541 undelayed lead time processes. Dataset C contains 506 cases which are determined as 114 delayed lead time processes and 392 undelayed lead time processes.

The confusion matrices [7] are used for evaluating the accuracy of the proposed approach. Tables 2, 3, and 4 present the results from three datasets (event logs).

Table 2 represents the result from dataset A, which has the prediction accuracy as 88.33%. The prediction of the delayed process lead time for class precision accuracy is 87.88%, and class recall is 74.36%. The prediction of the undelayed process lead time for class precision accuracy is 88.51%, and class recall is 95.06%.

Table 3 presents the prediction accuracy of the dataset B, which is 82.11%. The prediction of the delayed process lead time for class precision accuracy is 70.40%, and class recall is 93.61%. The prediction of the undelayed process lead time for class precision accuracy is 84.56%, and class recall is 48.89%.

Table 2: Classification result of dataset A

	True delay	True not delay	Class precision
pred. delay	29	4	87.88%
pred. not delay	10	77	88.51%
class recall	74.36%	95.06%	accuracy: 88.33%

Table 3: Classification result of dataset B

	True delay	True not delay	Class precision
pred. delay	37	88	70.40%
pred. not delay	504	92	84.56%
class recall	48.89%	93.16%	accuracy: 82.11%

Table 4: Classification result of dataset C

	True delay	True not delay	Class precision
pred. delay	61	22	73.49%
pred. not delay	53	370	87.47%
class recall	53.51%	94.39%	accuracy 85.18%

Table 4 presents the prediction accuracy of the dataset C, which is 85.18%. The prediction of the delayed process lead time for class precision accuracy is 73.49% and class recall is 94.39%. The prediction of the undelayed process lead time for class precision accuracy is 87.47% and class recall is 53.51%.

Fig. 3 depicts the summary results as a graph. The x-axis is datasets, the y-axis is the percentile of accuracy, and the lines show the types of accuracy from confusion table 2, 3, and 4. The best result in accuracy is dataset A. And, the accuracy of dataset B and C are just slightly lower. The accuracy of precise and recall in the case of the undelayed process from all datasets are relatively high and trivially different.

On the contrary, the accuracy of the delayed process prediction is different among the three datasets. In dataset A, it has the highest accuracy of precision, which is 87.88%. While dataset B and C have lower accuracies of precision, which are 70.40% and 73.49% respectively.

For the recall accuracy of delayed processes, it is the lowest accuracy. In dataset A, even though, the accuracy of the recall is the lowest among other types, but the percentage of the recall accuracy is relatively good when compare it with dataset B and C. For dataset B and C, they have the lowest accuracy when they are compared with other types of accuracy. The accuracy of the delayed process prediction of dataset B and C are about only 50%.

Figure 3: Prediction accuracy by given relevant context information

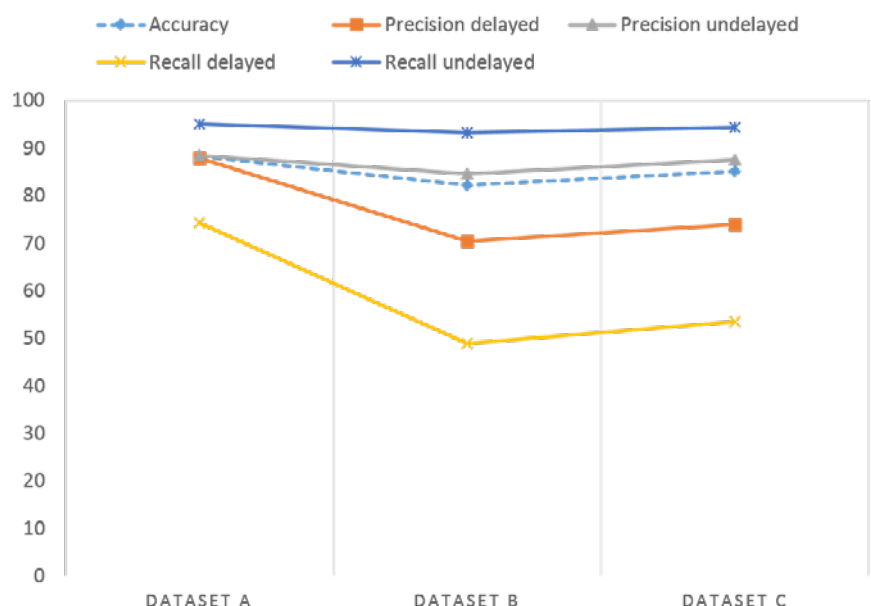

This addresses that the relationship between process lead time and relevant context information (the number of process activities which compete for same resources and the process lead time of the previously completed order whether it was delayed) has a certain degree of relationship. However, considering the accuracy of class recall when predicting delayed processes, the relationship of process lead time and relevant context information is not well reliably identified in dataset B and C.

Conclusion

Manufacturing and logistics systems need analytical revision to identify and evaluate the possible specific improvement actions. Process mining is a potential tool for process discovery and analysis. It provides organizations with knowledge to understand how business processes performed. However, process mining has limitations when it has to cope with less-structured data. Besides that, it needs new methodologies and innovative concepts to deal with the dynamic environment.

Integrating relevant context information in process analysis is enable us to find the insight knowledge of process behaviors. Therefore, we proposed a new approach to cope with these challenges. We focus on the methodology to capture and analyze the relevant context information which influence process lead time. We select two process contexts to analyze the influence to process lead time: (1) the number of process activities which compete for the same resources, and (2) the process lead time of the previously completed order whether it was delayed. The result of our experiment shows that these two contexts have a relatively high degree of relationship with process lead time in dataset A. In dataset B and C the two contexts have a certain degree of relationship with process lead time but are not well reliability identified be-

cause the prediction accuracy of class recall is relatively low in dataset B and C.

References

- [1] Eidhammer, O., Andersen, J. and Johansen, B. G. (2016). *Private Public Collaboration on Logistics in Norwegian Cities. Transportation Research Procedia*, 16, pp. 81-88.
- [2] Graham, G., Mehmood, R. and Coles, E. (2015). *Exploring future cityscapes through urban logistics prototyping: A technical viewpoint. Supply Chain Management: An International Journal*, 20(3), pp. 341-352.
- [3] Österle, I., Aditjandra, P. T., Vaghi, C., Grea, G. and Zunder, T. H. (2015). *The role of a structured stakeholder consultation process within the establishment of a sustainable urban supply chain. Supply Chain Management: An International Journal*, 20(3), pp. 284-299.
- [4] Roeder, T. M. K., Frazier, P. I., Szechtman, R., Zhou, E., Huschka, T. and Chick, S. E. *A Simheuristic algorithm for horizontal cooperation in urban distribution: application to a case study in Colombia.*
- [5] Rose, W. J., Mollenkopf, D. A., Autry, C. W. and Bell, J. E. (2016). *Exploring urban institutional pressures on logistics service providers. International Journal of Physical Distribution & Logistics Management*, 46(2), pp. 153-176.
- [6] Stathopoulos, A., Valeri, E. and Marcucci, E. (2012). *Stakeholder reactions to urban freight policy innovation. Journal of Transport Geography*, 22, pp. 34-45.
- [7] van Heeswijk, W., Mes, M. and Schutten, M. (2016). *An Agent-Based Simulation Framework to Evaluate Urban Logistics Schemes. In International Conference on Computational Logistics, Springer International Publishing*, pp. 369-383.

*Co-Author

Till Becker



Wacharawan Intayoad, M.Sc.

Email: int@biba.uni-bremen.de
 Country: Thailand
 Start: 15.07.2016
 Supervisor: Prof. Dr. Otthein Herzog, Prof. Dr. Till Becker
 Faculty: Mathematics / Computer Science
 Research Group: Production Systems and Logistic Systems
 Funded by: Erasmus Mundus project gLINK

The Role of Transportation Infrastructure in China-Pakistan Economic Corridor

China has signed an economic corridor with Pakistan that is one of the projects of its Belt and Road Initiative (BRI). So far, China has approved \$62 billion to invest in Pakistan. Although most of this investment is allotted to energy generation projects, the importance of infrastructural projects cannot be stressed enough. These infrastructure projects include road, railway, and maritime transportation networks. We focus on the role of transportation infrastructure in making China-Pakistan Economic Corridor a success story by analyzing the impact of transportation on economic growth.

Ayesha Khan*

Introduction >>> In April 2015, Pakistan and China signed a long term project that is one of the six corridors of BRI (Belt & Road Initiative), namely, China & Pakistan Economic Corridor (CPEC). This corridor consists of several infrastructure and energy-related projects. Pakistan is the 24th largest economy in the world in terms of purchasing power parity and 42nd largest in terms of nominal GDP (Pakistan Bureau of Statistics (PBIS), 2017). Its geographical location and large endowment of natural resources, make it one of the most important countries in the region. That is the reason that China (which is the 2nd biggest economy in the world) decided to take its all-weather friendship with Pakistan to even a higher level, in the form of CPEC. This plan comprises of road, railway transportation networks, energy power plants, port, and special economic zones development, and cross border optical fiber cable installation (Ministry of Planning, Development, and Reform, 2017). Given the history of mutual trust between two countries, CPEC was approved in April 2015 without any resistance from both sides.

The key player is the Gwadar port situated on the Arabian Sea, it is partially functioning right now, but it is supposed to be fully functional in the next few years. This port will provide Pakistan with new opportunities to engage in maritime business and logistics. However, Pakistan needs to improve its logistics and supply chain management capabilities to compete with regional as well as international competitors. Cur-

rently, Pakistan's LPI (logistic performance indicator) is 2.92 which is less than that of India's or China's that is 3.42 and 3.66 respectively (Connecting to Compete Trade Logistics in the Global Economy, 2018). Lack of infrastructure facilities and low-quality transportation networks could hinder the economic corridor. Therefore, several transportation projects are being pursued under CPEC. So far, China has financed \$62 billion under CPEC (Siddiqui, 2017). This project might be just a gateway for China, but it holds significant economic and socio-political implications for Pakistan. Figure 1 shows the geographical picture of CPEC.

The physical infrastructure development in CPEC mainly consists of land and maritime trade networks, but in order to fully utilize these trade networks, a sustainable and efficient transportation system is required. The corridor will cover around 3,000 km from Kashgar (China) to Gwadar (Pakistan). It includes 968 km of roads and 1830 km of railway networks ("Infrastructure | China-Pakistan Economic Corridor (CPEC) Official Website," n.d.). Authorities have decided to work on three different routes to connect Gwadar and Kashgar; Western alignment, central alignment, and eastern alignment (Peshawar Karachi Motorway). These routes connect Pakistan with China via the northern alignment road.

The mobility of physical products from Kashgar to Gwadar port must be supported by several types of logistics services, name-

ly, warehousing, shipping, and distribution. These logistics services should be available throughout the planned route of CPEC. However, the logistic industry in Pakistan is not well developed and there is room for a lot of improvement, especially in the context of CPEC. Figure 2 shows the different stakeholders involved in the development of logistic network under CPEC.

It can be seen that the stakeholders involved in CPEC comprise of national, international, and private agents. An international logistics network may affect these stakeholders including logistics service providers, investors, shippers, and infrastructure developers, among others (Sheu & Kundu, 2017). Henceforth, the scope of CPEC is quite broad, and it depends on transportation networks that provide connectivity among all these stakeholders. The next section explains how transportation infrastructure impacts the economy through different channels. <<<

Economic Evaluation of Transportation Infrastructure

Since the 1980s, the role of transportation has been extensively analyzed in literature. Several economic theories support the proposition that transportation infrastructure is one of the driving forces of an economy. Classical location theory suggests that economic activities depend on transportation cost. The New Economic Geography (NEG) theory emphasizes the role of transportation in determining the location of economic activities in the context of imperfect

Figure 1: Bird's Eye View of CPEC (Eder & Mardell, 2018)

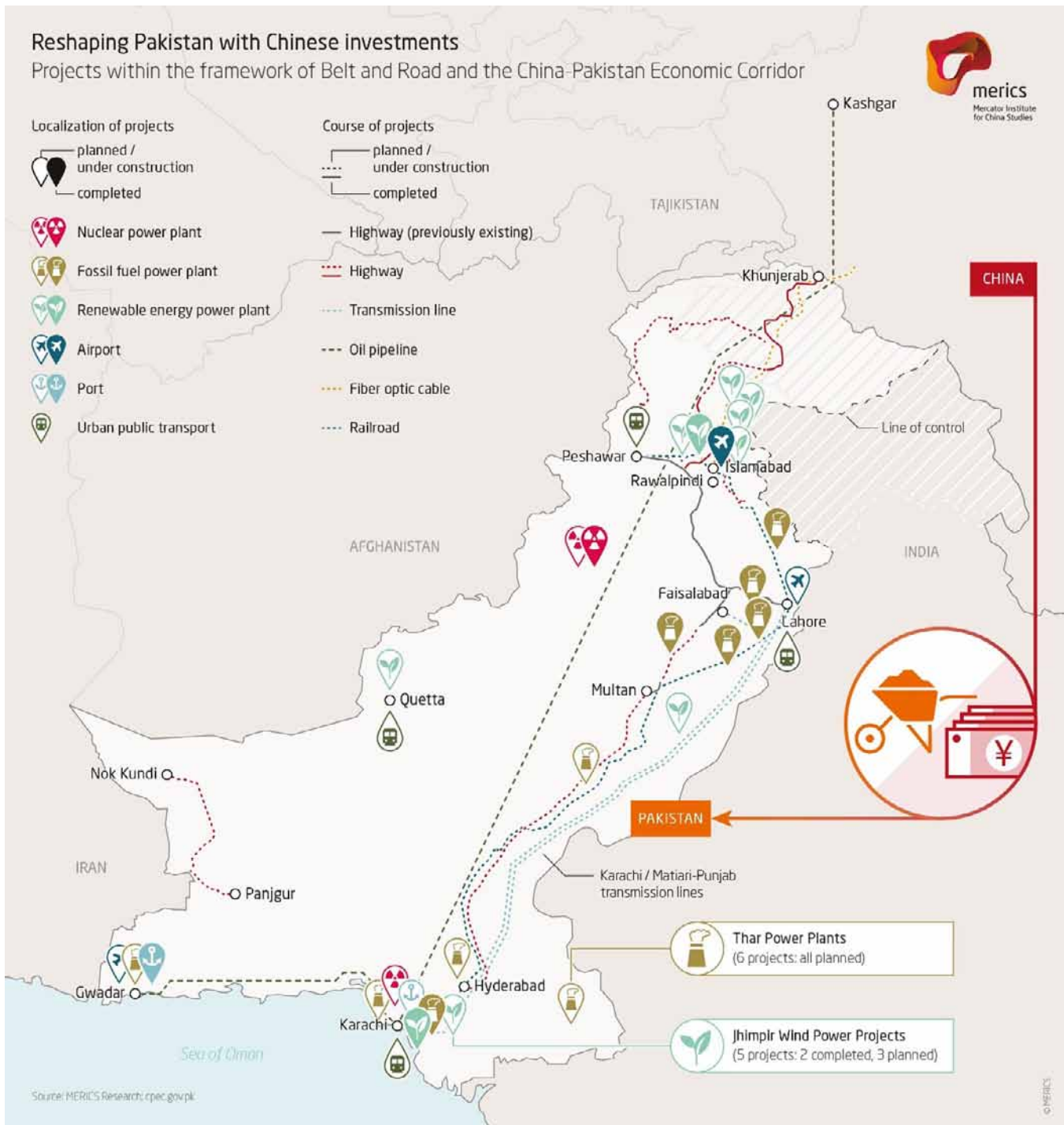

competition and interregional labor mobility. Moreover, the endogenous theory of growth also considers transportation infrastructure as a determinant of technical change that is a source of economic growth (Melo, Graham, & Brage-Ardao, 2013).

The economic impact of transportation investment can be classified into two categories, namely temporary or short term and long term effects. The short term effects are generated from construction activities when the demand side is affected by

investment expenditure during the construction phase. The latter refers to structural or long term effects resulting from operation and maintenance activities; during this phase, capital accumulation is generated through improved accessibility. The long term effects are further divided into direct and indirect effects. The direct effects depend on the reduction in travel time and transportation cost, and then they are further translated into indirect effects via spill-overs or inter-linkages of economic activities in the region. These spill-overs include

impacts on industrial agglomeration, the spatial aspect of a transportation network, spatial and agglomeration of business activities, travel behavior, productivity, migration and knowledge sharing (Kim, Hewings, & Amir, 2017). Agglomeration economies refer to the benefits which occur when economic agents work closer to each other in terms of spatial economy, and transport-induced agglomeration economies change the degree of access people have to economic activities and thus the productivity (Aggarwal, 2011; Hylton & Ross, 2017).

Figure 2: Stakeholders involved in CPEC (Adapted from [11])

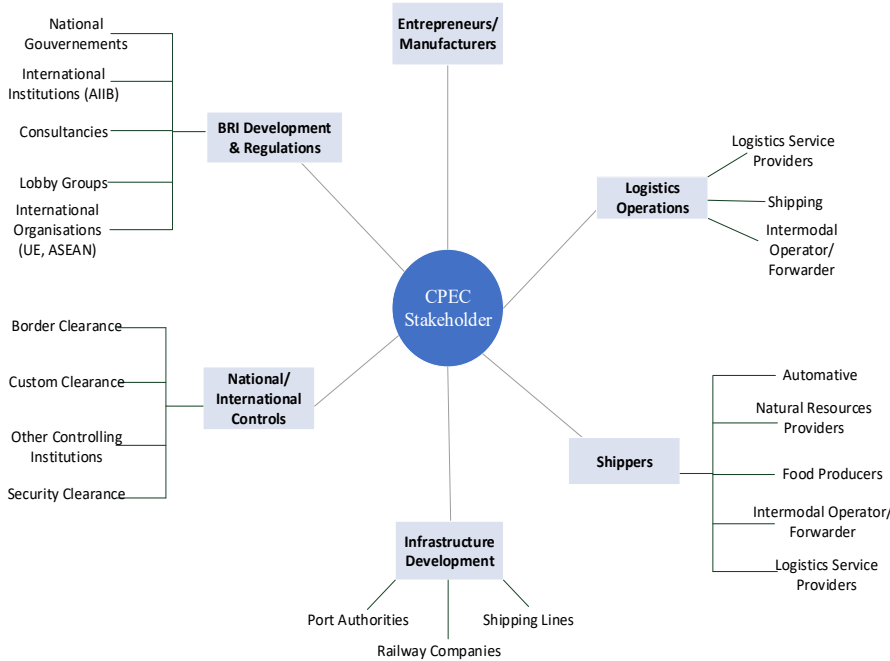

Moreover, improved productivity and better accessibility will attract FDI, which will open new doors of opportunities for local labor and capital. It is also believed that inflow of FDI in developing countries also brings in advanced technology, which will lead to a technological upgrade of the domestic economy, and that will again affect the accessibility. The cycle goes on and it is evident that transportation infrastructure affects economic growth via several channels both in the short term and long term (Bruinsma, Rienstra, & Rietveld, 1997; Kim et al., 2017; Li, Jin, Qi, Shi, & Ng, 2017).

These short term and long term effects of transportation infrastructure are important for several key stakeholders involved in CPEC, such as shippers, logistics service providers, entrepreneurs, port authorities, and manufacturers. Developing transportation facilities will be the first step in building a logistics network to manage the supply chain. Well planned and high quality transportation networks will enable these stakeholders to work more efficiently and run a smooth domestic and international trade network.

Figure 3: Schematic Structure of Role of Transport Infrastructure in Economic Development

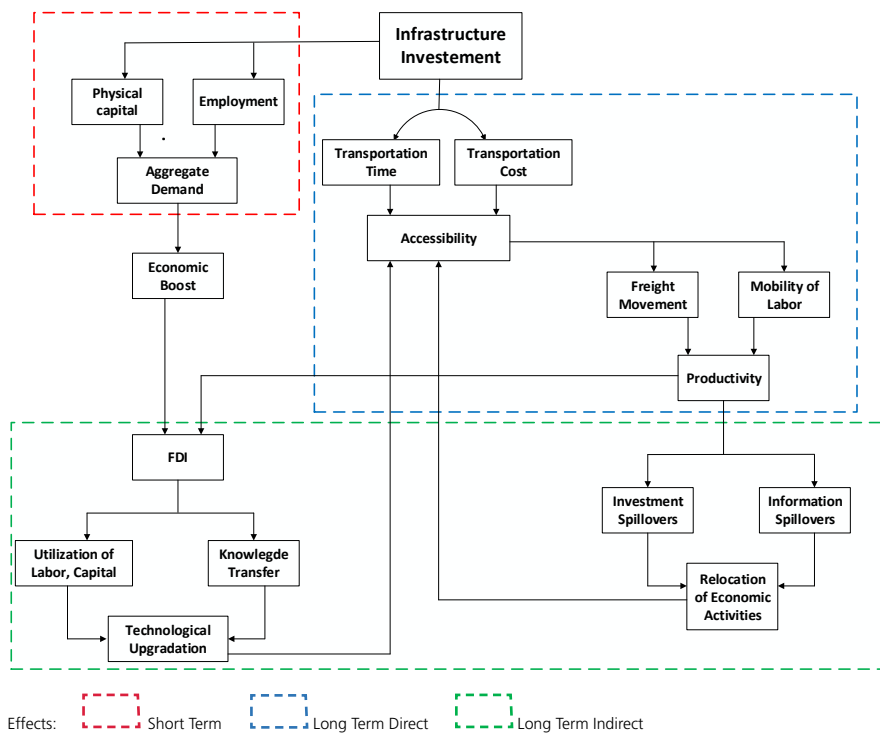

Conclusion

Pakistan's economy is facing challenges partly due to a bottleneck of energy and infrastructure sector. In Pakistan, the lack of infrastructure facilities results in an economic loss of 6 percent of its GDP (Li, Jin, Qi, Shi, & Ng, 2017). Improving the situation by developing infrastructure facilities will not only recover this loss, but it will also generate additional benefits for the economy. If the planned transportation projects are completed in time, i.e., by 2020 and some by 2030, they will affect the economy via several channels as described in the previous section and therefore, contribute positively in economic growth.

Figure 3 exhibits how infrastructure investment leads to economic development. The short term economic boost is highlighted by a red box. Whereas, the long term effects are further divided into direct and indirect effects. Initially, direct effects materialize and later they stimulate indirect spill-overs. The first important feature of direct impacts is the improvement in the accessibility and reachability for the masses and for trade and freight which in turn will

cause productivity to increase. This increased productivity will result in spatial spill-overs and inflow of foreign direct investment (FDI). Spatial spill-over could be in the form of investment ventures in the neighboring regions and transferring of information. It will improve the business conditions of the neighbor regions, and hence, it will be an incentive to relocate economic activities.

References

- [1] Aggarwal, A. (2011). Promoting Agglomeration Economies and Industrial Clustering Through SEZs: Evidence from India. *Journal of International Commerce, Economics and Policy*, 2(2), pp. 201–227. <https://doi.org/10.1142/S1793993311000282>
- [2] Bruinsma, F. R., Rienstra, S. A. and Rietveld, P. (1997). Regional Studies Economic Impacts of the Construction of a Transport Corridor: A Multi-level and Multiapproach Case Study for the Construction of the A1 Highway in the Netherlands. *Regional Studies*, 31(4), pp. 391–402. <https://doi.org/10.1080/00343409750132991>
- [3] (2018): Connecting to Compete - Trade Logistics in the Global Economy. Washington DC. <https://openknowledge.worldbank.org/bitstream/handle/10986/29971/LPI2018.pdf> (Accessed May 2, 2019)
- [4] Eder, T. S. and Mardell, J. (2018). The BRI in Pakistan: China's flagship economic corridor | Mercator Institute for China Studies. Retrieved April 30, 2019, from <https://www.merics.org/en/bri-tracker/the-bri-in-pakistan>
- [5] Hylton, P. J. and Ross, C. L. (2017). Agglomeration economies' influence on logistics clusters' growth and competitiveness. *Regional Studies*. <https://doi.org/10.1080/00343404.2017.1327708>
- [6] Infrastructure | China-Pakistan Economic Corridor (CPEC). Retrieved March 20, 2018, from <http://cpec.gov.pk/infrastructure>
- [7] Kim, E., Hewings, G. J. D. and Amir, H. (2017). Economic evaluation of transportation projects: An application of Financial Computable General Equilibrium model. *Research in Transportation Economics*, 61, pp. 44–55. <https://doi.org/10.1016/j.retrec.2016.09.002>
- [8] Li, K. X., Jin, M., Qi, G., Shi, W. and Ng, A. K. Y. (2017a). Logistics as a driving force for development under the Belt and Road Initiative – the Chinese model for developing countries. <https://doi.org/10.1080/01441647.2017.1365276>
- [9] Melo, P. C., Graham, D. J. and Brage-Ardao, R. (2013). The productivity of transport infrastructure investment: A meta-analysis of empirical evidence. *Regional Science and Urban Economics*, 43, pp. 695–706. <https://doi.org/10.1016/j.regsciurbeco.2013.05.002>
- [10] Ministry of Planning, Development and Reform. (2017). Long Term Plan for China-Pakistan Economic Corridor. Ministry of Planning Development & Reform, Government of Pakistan, (December 2016), 36. <http://pc.gov.pk/uploads/cpec/LTP.pdf>
- [11] Nazarko, J. and Kuźmicz, K. A. (2017). Introduction to the STEEPVL Analysis of the New Silk Road Initiative. *Procedia Engineering*, 182, pp. 497–503. <https://doi.org/10.1016/j.PROENG.2017.03.143> (Accessed March 26, 2018)
- [12] Pakistan Bureau of Statistics (PBS). (2017). Pakistan Census. <http://www.pbs.gov.pk/content/population-census> (Accessed March 20, 2018)
- [13] Sheu, J. B. and Kundu, T. (2017). Forecasting time-varying logistics distribution flows in the One Belt-One Road strategic context. *Transportation Research Part E: Logistics and Transportation Review*. <https://doi.org/10.1016/j.tre.2017.03.003>
- [14] Siddiqui, S. (2017). CPEC investment pushed from \$55b to \$62b. *Tribune.Com.Pk*. <https://tribune.com.pk/story/1381733/cpec-investment-pushed-55b-62b/> (Accessed March 20, 2018)

*Co-Author

Hans-Dietrich Haasis



Khan Ayesha, M.phil.

Email: ayesha@uni-bremen.de
Country: Pakistan
Start: 03.10.2017
Supervisor: Prof. Dr. Dr. h.c. Hans-Dietrich Haasis
Faculty: Business Studies / Economics
Research Group: Business Administration, Maritime Business and Logistics
Funded by: DAAD

Evaluating Forwarding Protocols in OppNets: Trends, Advances and Challenges

There exists a variety of applications and forwarding protocols in Opportunistic Networks literature. However, the methodology of evaluation, testing, and comparing these protocols are not standardized yet, leading to large levels of ambiguity in performance evaluations. More comparability in evaluation scenarios and methodologies would improve also the availability of protocols and the repeatability of studies. Here, we explore the evaluations rather than what they actually achieve. Further, we deduce some best practices for achieving the largest impact of future evaluation studies.

Introduction >>> Opportunistic Networks (OppNets) enable the devices to connect and exchange data as the opportunity arises. Real testbeds to study and evaluate OppNets are uncommon as the repeatability of the experiment is a huge challenge. The dynamics of the network and the users' mobility makes it impossible. Thus, simulators are the most preferred way of evaluating OppNets. Bridging the gap between real-world studies and simulations is often done by capturing the real-world traces or by performing evaluations with a large range of scenarios, to ensure the statistical significance of the evaluations. As benchmarks for OppNets do not exist, the researchers postulate suitable evaluation configurations and experimental setups for their studies. In this report, we study the aspects of OppNet performance evaluations, discuss the challenges in conducting OppNet evaluations, and propose best practices for enhancing the credibility of future OppNet evaluations. <<<

Simulators

There are two main classes of simulators to perform OppNet evaluations: custom-built simulators and standard simulators. Standard simulators usually used for OppNets are ONE, OMNeT++, ns-3, and Adyton. For both custom-built and standard simulators, one can also provide the original code for reproducibility purposes. Figure 1 shows the network simulators used in all explored studies and the recent ones since 2013. An observed tendency is that recent studies use

more standard simulators, especially the ONE, and less custom-built ones. This is a positive trend, as it helps towards re-usage of models and reproducibility.

However, standard simulators typically are of general use and tend to be slower, potentially limiting the scale of the OppNet simulation. On the other-hand, custom-built simulators provide speed and optimization, but they tend to be simpler and ignore many important properties.

The authors in [1] study the availability of simulation models and conclude that the ONE has the largest variety of simulation models, while C++ based simulators like OMNeT++ or Adyton are much faster. Hence, one can choose simulators based on the availability of time and resources. However, it is essential to making the original code available to the research community

and to carefully design the evaluation methodology.

Comparative Studies

One of the significant decisions for designing an evaluation study is whether to compare the new protocol against some existing ones or not. Researchers often compare their new protocols against available and well-explored ones, rather than the most relevant ones. In the case of OppNets, these protocols are typically Epidemic [2], ProPhet [3], Spray & Wait [4], and BubbleRap [5]. It is observed that the freely available implementations of protocols are preferred options for comparison. Thus, the newer protocols are not evaluated against each other. For example, both Predict & Forward [3] from 2018 and PathSampling [2] from 2016 were compared against



Figure 1: Evaluation environments used in the studies considered

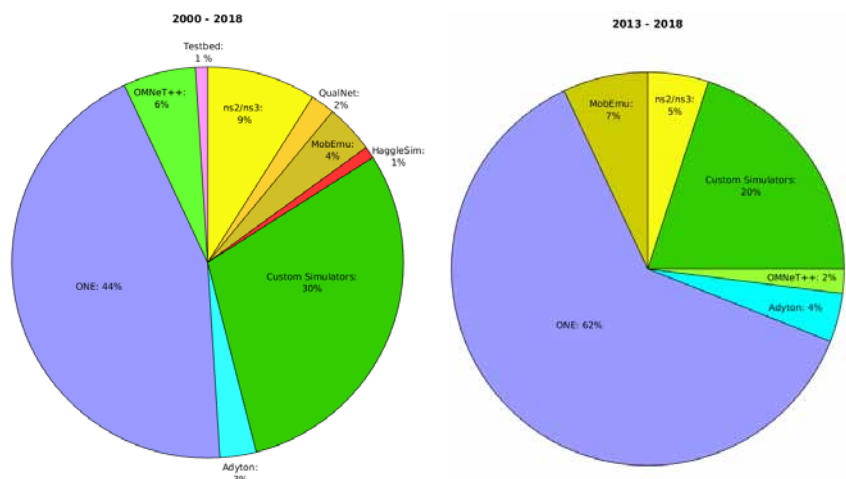

Epidemic and Spray&Wait. However, they seem close enough in their application scenarios to each other, as both had selected the same set of comparative protocols.

These observations have led us to emphasize that the new protocols need to be implemented in standard simulators and their code needs to be published. This enables future studies to use the most recent advances in the area. It can also result in reproducing and confirming the available results, pushing the state of the art forward. Comparative studies against traditional protocols can be valuable to set the new protocol in context.

Scalability

Scalability in OppNets is directly related to the network size. Most of the studies have been evaluated for a network size of fewer than 100 nodes. Very few evaluations have considered nodes above 200, and the trend declines rapidly for 500, 1000 nodes and above. Large simulations with thousands of nodes are still hard to achieve, which is one of the most important challenges and goals for OppNet modeling. New studies should target at least 500 – 1000 nodes. Some special application scenarios might require a custom scale.

Mobility

Mobility is the main driver of OppNets and how messages get diffused in the network. The properties relevant for mobility models are scalability, realism, and generalization. Random and hybrid mobility models can be simulated with as many nodes as needed. However, traces are limited to the maximum number of nodes used in data collection. In terms of realism, real traces are clearly real. Random models are least realistic, while hybrid models tend to have more realistic properties. For generalization, a single real trace is a snapshot and thus not representative. Analytical models, when

Figure 2: Properties of standard mobility models (left) and extension opportunities for trace-based models (right)

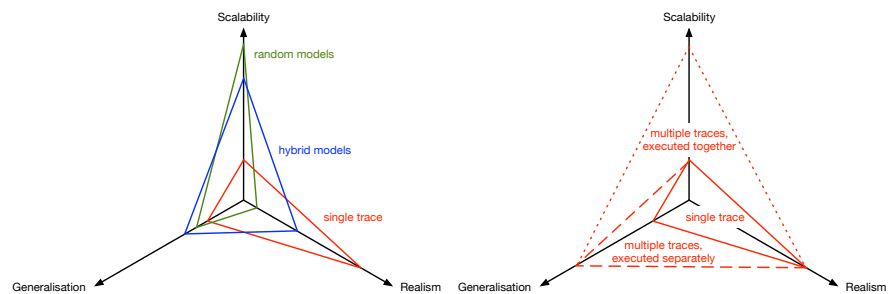

used for a large number of scenarios, become representative studies with statistical significance. Figure 2 shows varying degrees of relevance of different mobility models in terms of generalization, realism, and scalability.

Until recently, the mobility models have been used exclusively. However, other approaches, such as running simulations with several mobility models separately and together, are also possible. In the first idea, a simulation is run first with mobility model A, then with B, C, etc. All results together are used to derive the performance of the explored protocol. In the second idea, individual traces are not run separately from each other, but on top of each other. The coordinate systems of the individual traces need to be converted to match. In this way, a much more scalable and dense simulation is possible, which makes the performance evaluation scalable and general at the same time. In the OppNet evaluations so far, there is a slight trend towards using more than two traces or at least one trace and one analytical model. This is an encouraging trend, as it makes the studies more representative.

References

[1] Dede, J. et al. (2017). *Simulating opportunistic networks: Survey and future directions*. *IEEE Communications Surveys & Tutorials*, 20(2), pp. 1547-1573.

[2] Vahdat, A. et al. (2000). *Epidemic routing for partially connected ad hoc networks*. <http://issg.cs.duke.edu/epidemic/epidemic.pdf>, accessed on June, 6, 2019.

[3] Lindgren, A. et al. (2004). *Probabilistic routing in intermittently connected networks*. *International Workshop on Service Assurance with Partial and Intermittent Resources*. Berlin, Heidelberg: Springer.

[4] Spyropoulos, T. et al. (2005). *Spray and wait: an efficient routing scheme for intermittently connected mobile networks*. *Proceedings of the 2005 ACM SIGCOMM workshop on Delay-tolerant networking*. <http://dx.doi.org/10.1145/1080139.1080143>

[5] Hui, P. et al. (2011). *Bubble rap: Social-based forwarding in delay-tolerant networks*. *IEEE Transactions on Mobile Computing*, 10(11), pp. 1576-1589.

[6] Visca, J. et al. (2016). *Path sampling, a robust alternative to gossiping for opportunistic network routing*. *2016 IEEE 12th International Conference on Wireless and Mobile Computing, Networking and Communications (WiMob)*. <http://dx.doi.org/10.1109/WiMOB.2016.7763244>

[7] Liu, K. et al. (2018). *Predict and Forward: An Efficient Routing-Delivery Scheme Based on Node Profile in Opportunistic Networks*. *Future Internet*, 10(8), p.74.

*Co-Authors

Udaya Miriya Thantrige
Asanga Udugama
Anna Förster



Vishnu Priya Kuppusamy Parimalam, M.Tech.

Email: vp@comnets.uni-bremen.de
Country: India
Start: 01.10.2016
Supervisor: Prof. Dr. Anna Förster
Faculty: Physics / Electrical Engineering
Research Group: Sustainable Communication Networks
Funded by: DAAD

Operator-based Decentralized Capacity Control of Job-shop Systems with RMTs

Customers quickly changing demands regarding types of products, quantities and delivery dates are a big challenge for manufacturers. Capacity adjustment by using reconfigurable machine tools is one approach to deal with these challenges. However, disturbances (e.g. rushed orders and machine break down) and delays (e.g. transportation delay and reconfiguration delay) are great challenges for the manufacturers. In order to deal with these problems, we propose a decentralized architecture by using an operator-based robust right coprime factorization method to improve the capacity control process of job shop systems. We illustrate the applicability and efficiency of this approach by simulation of a four-workstation job-shop system.



Introduction >>> Capacity adjustment of job-shop manufacturing systems has attracted much attention. In contrast to traditional labor-based approaches, Reconfigurable Machine Tools (RMT) as one advanced technology of Industrie 4.0 provides an opportunity for machinery-based capacity adjustment, which cannot be achieved by using Dedicated Machine Tools (DMT) only. In [1], RMTs harmonizing throughput-time capacity control approach was utilized to plan the delivery dates and analyze the inventory range of each workstation considering reconfiguration delay. Proportional-Integral-Differential (PID) [2,3] control method was applied to capacity adjustment, and a mathematical model of

job-shop systems was developed including new degree of freedom of RMTs. Furthermore, the respective model was continuously extended by including the WIP and planned WIP level of each workstation and a model predictive control (MPC) approach was applied considering time-varying input orders [4].

However, job-shop systems are not simple single-input-single-output (SISO) systems, but instead show nonlinear dynamics as well as a multi-input-multi-output (MIMO) structure with strong coupling between the workstations (subsystems). Additionally, this system also suffers from many disturbances and delays, which are unaccounted for in the literature. Operator-

based robust right coprime factorization (RRCF) [5] is one opportunity to deal with these issues and has been studied for the above application in [6]. Robust stability of a respective closed loop with unknown bounded disturbance was studied in [7,8]. Tracking control for delays or time-varying delays was considered in [9,10]. Additionally, decoupling techniques were studied in [11,12].

We will include transportation delays between workstations, reconfiguration delays of RMTs, and rush orders into the capacity control process of job-shop systems. In the design of capacity control, a decentralized architecture has an advantage of responding quickly for the feedback state [13]. In order to improve the competitiveness of job-shop manufactures facing fast changing customer demands, we especially focus on a fast capacity control design for a disturbed and time-delayed job-shop system in a decentralized form. At first, we will shortly describe the job-shop model in Section 2. Thereafter, in Section 3 we propose the capacity control design and show simulation results in Section 4 before drawing conclusions in Section 5. <<<

Mathematical Model

Following [3], each workstation can be represented as a control system of the form where we utilize the variables defined in Table 1.

Table 1: Variables within a job-shop system with RMTs

Variable	Description
$X_{kj}(t)$	Orders input rate from workstation k to j for $k, j \in \{0, \dots, n\}$
$u_j(t)$	Number of RMTs in workstation $j \in \{1, \dots, n\}$
$y_j(t)$	WIP level of workstation $j \in \{1, \dots, n\}$
p_{jk}	Flow probability from workstation j to k for $j, k \in \{0, \dots, n\}$
p_{j0}	Flow probability from workstation $j \in \{1, \dots, n\}$ to final stage
p_{0j}	Flow probability from initial stage to workstation $j \in \{1, \dots, n\}$
n^{RMT}	Number of RMTs in the system
n_j^{DMT}	Number of DMTs in workstation $j \in \{1, \dots, n\}$
n^{DMT}	Number of DMTs in the system, which is equal to $\sum_{j=1}^n n_j^{DMT}$
v_j^{DMT}	Production rate of DMTs in workstation $j \in \{1, \dots, n\}$
v_j^{RMT}	Production rate of RMTs in workstation $j \in \{1, \dots, n\}$
$d_j(t)$	Disturbances in workstation $j \in \{1, \dots, n\}$
τ_1	Reconfiguration delay
τ_2	Transportation delay

$$\begin{aligned} \dot{y}_j(t) = & X_{0j}(t - \tau_2) + \\ & \sum_{k=1}^n p_{kj} \cdot (n_k^{DMT} \cdot v_k^{DMT} + u_k(t - \tau_2 - \tau_1) \cdot v_k^{RMT}) + \\ & \cdot d_j(t) - (n_j^{DMT} \cdot v_j^{DMT} + u_j(t - \tau_1) \cdot v_j^{RMT}) \end{aligned} \quad (1)$$

Each workstation may receive orders from the initial stage ($k = 0$) and workstation $k \in \{1, 2, \dots, n\}$, and delivers its products to a final stage ($i = 0$) and workstation $i \in \{1, 2, \dots, n\}$ according to the flow probabilities p_{ji} satisfying

$$\sum_{i=0}^n p_{ji} = 1 \text{ for all } j \in \{1, \dots, n\}.$$

Each workstation is equipped with a fixed number of DMTs and may be assigned a variable number of RMTs. We suppose that all RMTs can be used within all workstations, but only perform one operation at the specific period, which reveals the constraints.

$$u_j(t) \in \mathbb{N}_0 \text{ and } \sum_{j=1}^n u_j(t) \leq n^{RMT}. \quad (2)$$

Note that there are two difficulties arising from constraints (2): For one, the upper bound is formulated for the entire job-shop system and not a single workstation, and secondly, the requirement $u_j(t) \in \mathbb{N}_0$ represents a discrete constraint in a continuous setting.

We like to note that the model (1) only applies if the system is working on high WIP level. In this case, the orders output rate equals the maximum capacity, i.e. the WIP level can be controlled via the assignment of RMTs $u_j(\cdot)$ for all workstations.

Capacity Control

Based on the mathematical model from the previous section, we follow [9] and obtain the right factorization

$$\begin{aligned} w_j(t) = & D_j^{-1}(u_k(t - \tau_2 - \tau_1))(u_j(t - \tau_1)) \\ & = X_{0j}(t - \tau_2) + \\ & \sum_{k=1}^n p_{kj} \cdot (n_k^{DMT} \cdot v_k^{DMT} + u_k(t - \tau_2 - \tau_1) \cdot v_k^{RMT}) - \\ & (n_j^{DMT} \cdot v_j^{DMT} + u_j(t - \tau_1) \cdot v_j^{RMT}) \end{aligned} \quad (3)$$

$$\begin{aligned} y_j(t) = & N_j(w_j(\cdot)) + \Delta N_j(d_j(t)) = y_j(0) + \\ & \int w_j(t) + d_j(t) dt \end{aligned} \quad (4)$$

In (3), the coupling between the workstations is given by solving the latter n linear systems, we obtain

$$u_j(\cdot) = \sum_{k=1}^n D_{jk}(w_k)(\cdot), \quad j = 1, 2, \dots, n.$$

To avoid the difficult computation of an RRCF control for the MIMO system, we utilize decoupling as proposed in [12] to trans-

Figure 1: Nonlinear feedback tracking control of MIMO system

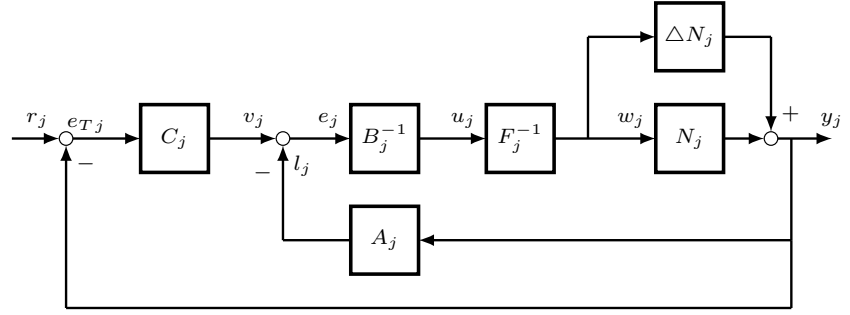
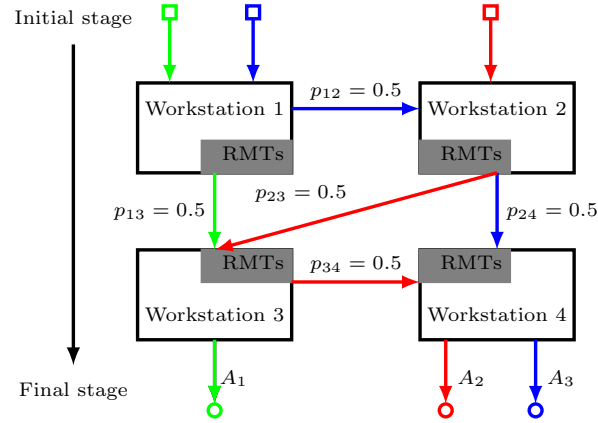

Figure 2: Four-workstation job-shop manufacturing system with RMTs



fer it into simple SISO systems. To obtain n independent SISO systems, the decoupling controller H and G need to satisfy

$$\sum_{k=1, k \neq j}^n [H_{jk}(w_j)](w_k) + G_j D_{jk}(w_k) = 0 \quad (5)$$

$$H_{jj}(w_j) + G_j D_{jj}(w_j) = F_j(w_j) \quad (6)$$

where G_j is linear and F_j is stable and invertible.

Here, we assume the decoupling operator $G = (G_1, G_2, \dots, G_n)$ to be identity operators, H_{jj} to be unimodular for $j = 1, 2, \dots, n$, and $(H_{jk}(w_j))(w_k) = -G_j D_{jk}(w_k)$. Combining the latter with (5), (6), we obtain

$$F_j(w_j) = H_{jj}(w_j) + D_{jj}(w_j), \quad j = 1, 2, \dots, n$$

where F_j is stable and invertible, i.e. the MIMO system to be decoupled. Now the RRCF operators A_j and B_j can be designed

following the Bezout identity $A_j \circ (N_j + \Delta N_j) + B_j \circ F_j = M_j$.

In order to track a given WIP level, we integrate a tracking controller C_j as proposed in [7], cf. Figure 1 for a sketch. Note that as the number of RMTs is integer, the controller can only practically asymptotically stabilize the system, cf. [14, Chapter 2], where the maximal difference between the planned WIP and current WIP is less than the production rate of one RMT in that workstation.

Case Study

To evaluate our proposed controller, we consider a four-workstation job-shop system where bounded disturbances and delays are considered. The flow probabilities for the three different products A_1 , A_2 , A_3 given by p_{jk} of the orders output from

Table 2: Parameters setting of the four-workstation system

Number of workstation	1	2	3	4
Initial WIP level	400	400	300	200
Planned WIP level	240	400	400	240
Orders input rate from initial stage	102	51	0	0
Number of DMTs	4	2	2	4
Production rate of DMTs	20	40	40	20
Production rate of RMTs	10	20	20	10

Figure 3: Dynamic performances of the four-workstation job shop system

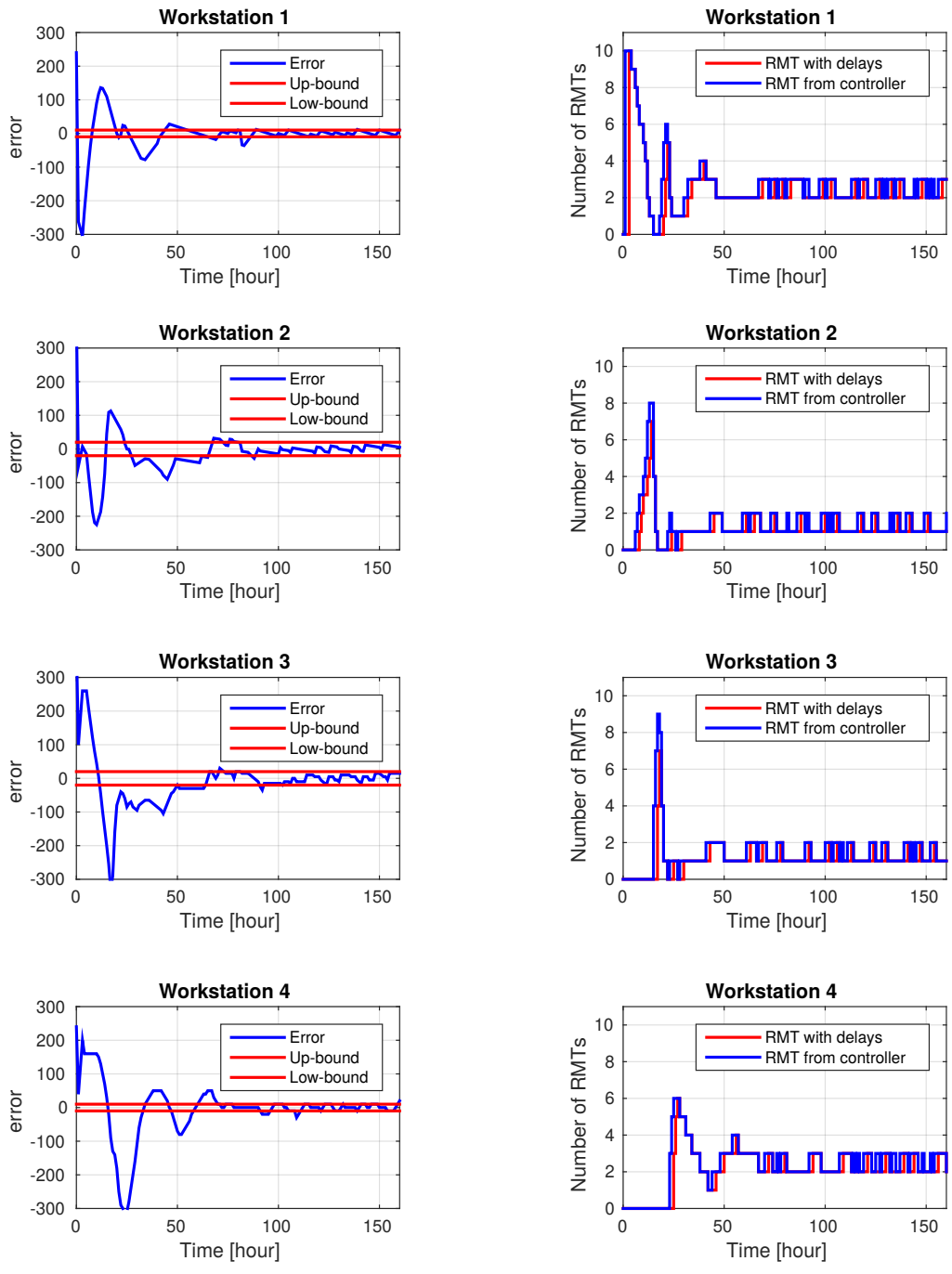

workstation j to workstation k and the final stage, cf. Figure 2. The parameters setting are shown in Table 2 and the scenario additionally features 10 RMTs and 40 and 20 rush orders to workstation 1 and 2 at time instant 80. For this setting, the resulting performances of all workstations with delays and disturbances are shown in Figure 3. As expected, we observe that the WIP level of each workstation is practically asymptotically stabilized with upper and lower deviation $\pm v_j^{RMT}$ from the planned WIP level. In the right figure, we observe the reconfiguration delay of two hours if the number of RMTs is increased. At time instant 80, due to the rush orders the WIP

levels of workstations 1 and 2 are suddenly increasing and the errors are out of the bound. Yet, the controller is compensating by allocating RMTs to workstation 1 and 2. After about 10 hours, the rush orders flow to workstation 3 and 4 and the controllers reconfigures the RMTs to these workstations ahead of time rendering the system to be practically stable again.

Conclusion and Outlook

In this paper, a mathematical model is extended to include transportation and reconfiguration delays as well as disturbances. Furthermore, RRCF method in decentralized architecture is proposed to deal with delays

and disturbances in the capacity adjustment of job-shop manufacturing systems with RMTs. The simulation results are additionally depicting the efficiency of the method. In future work, we will focus on the following points. The first one is to optimize the integer problem in the number of RMTs, which as the input of the system has a great influence on the dynamic performance. Another will be the modeling development. We will including more factors in the job-shop systems considering new freedom of RMTs.

References

- [1] Scholz-Reiter, B., Lappe, D. and Grundstein, S. (2015). Capacity adjustment based on reconfigurable machine tools - Harmonising throughput time in job-shop manufacturing. *CIRP Annals - Manufacturing Technology*, 64(1), pp. 403–406.
- [2] Kim, J. and Duffie, N. (2005). Design and analysis of closed-loop capacity control for a multi-workstation production system. *CIRP Annals - Manufacturing Technology*, 54(1), pp. 455–458.
- [3] Liu, P., Zhang, Q. and Pannek, J. (2016). Capacity adjustment of job shop manufacturing systems with RMTs. *Proceedings of the 10th International Conference on Software, Knowledge, Information Management and Application*, pp. 175–180 DOI: 10.1109/SKIMA.2016.7916217
- [4] Zhang, Q., Liu, P. and Pannek, J. (2017). Modeling and predictive capacity adjustment for job shop systems with RMTs. *Proceedings of the 25th Mediterranean Conference on Control and Automation*, pp. 310–315.
- [5] Chen, G. and Han, Z. (1998). Robust right coprime factorization and robust stabilization of nonlinear feedback control systems. *IEEE Transactions on Automatic Control*, 43(10), pp. 1505–1509.
- [6] Liu, P. and Pannek, J. (2017). Modelling and controlling of multi-workstation job shop manufacturing systems with RMTs. *6th CUST International Business Research Conference*, accepted.
- [7] Deng, M., Inoue, A. and Ishikawa, K. (2006). Operator-based nonlinear feedback control design using robust right coprime factorization. *IEEE Transactions on Automatic Control*, 51(4), pp. 645–648.
- [8] Wen, S., Liu, P. and Wang, D. (2014). Optimal tracking control for a peltier refrigeration system based on PSO. *2014 International Conference on Advanced Mechatronic Systems*, pp. 567–571.
- [9] Deng, M. and Inoue, A. (2008). Networked non-linear control for an aluminum plate thermal process with time-delays. *International Journal of Systems Science*, 39(11), pp. 1075–1080.
- [10] Bi, S., Deng, M. and Wen, S. (2011). Operator-based output tracking control for non-linear uncertain systems with unknown time-varying delays. *IET Control Theory and Applications*, 5(5), pp. 693–699.
- [11] Deng, M. and Bi, S. (2010). Operator-based robust nonlinear control system design for MIMO nonlinear plants with unknown coupling effects. *International Journal of Control*, pp. 1939–1946.
- [12] Bi, S., Xiao, Y. and Fan, X. (2014). Operator-based robust decoupling control for MIMO nonlinear systems. *The 11th World Congress on Intelligent Control and Automation*, pp. 2602–2606.
- [13] Lödding, H., Yu, K. W. and Wiendahl, H. P. (2003). Decentralized WIP-oriented manufacturing control (DEWIP). *Production Planning and Control*, 14(1), pp. 42–54.
- [14] Grüne, L. and Pannek, J. (2017). *Nonlinear Model Predictive Control: Theory and Algorithms*. Springer, 2nd edition.

*Co-Author

Jürgen Pannek

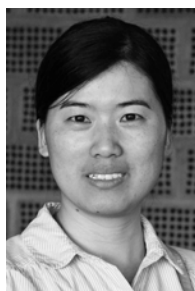

Ping Liu, M.Sc.

Email: liu@biba.uni-bremen.de
Country: China
Start: 28.07.2015
Supervisor: Prof. Dr. Jürgen Pannek
Faculty: Production Engineering
Research Group: Dynamics in Logistics
Funded by: Erasmus Mundus project FUSION and LogDynamics

Virtual Movement from Textual Instructions

One way of increasing automation lies in enabling multi-tasking robots to follow textual instructions. In order to contribute to this goal we took physical exercise instructions as our everyday activity domain. However, for a computer it is difficult to detect and extract this information. We present a model, which is a combination of a semantic parser and a Bayesian network that explicates the implicit information that is contained in the instructions so that an animation execution of the exercises can be performed by an avatar.

Himangshu Sarma



Introduction >>> The field of robotics is still held back from mainstream impact by a number of limitations regarding general purpose use; i.e., robots are designed only for specific (and limited) tasks. The same robot cannot be used for different types of work. Therefore, multitasking robots which can perform different tasks in households or industry, outside of strictly controlled manufacturing environments could be beneficial for the real world.

The focus of my thesis work is to support the development of multitasking robots that can perform different tasks using different text-based instructions, where the main input is the textual instruction (e.g. from online instruction repositories). Within that domain, I focus on generating a pipeline to extract specific action segments from text-based instructions with the help of HC methods. As an input users will be provided with text based instructions for exercises. 3D animations will automatically be generated as an output from the provided instruction sheet. <<<

Motivation

Exercise instruction sheets are one of the mediums used for performing exercises in daily life. Until now, developing a text to an animation system, as a first step towards multitasking robots are a big challenge. To develop an animation system, first a machine needs to understand the language perfectly. However, natural language understanding (NLU) is still a difficult task for machines, especially when it comes to non-declarative sentence, such as instructions, which are more complex and difficult for

NLU system. Extracting semantic information from these instructions is difficult because of its syntactic structures and large amount of implications. In these instructions, there are lots of underspecified information, which are not explicated in the textual instructions. Human brains can easily add this implicit information.

Research Approach

Motion-based games for health are subject to a growing body of research and development. In a series of studies, [1] have shown that playful applications can provide a number of benefits compared to traditional instruction by exercise sheets, especially when used to augment unsupervised exercising at home. We summarize these areas to be motivation (to perform repetitive exercises), feedback (regarding the current exercise execution and summarizing developments), and customization (by manual adaptations of automatic adaptivity) [2].

Such games can be created in a modular fashion, where the specific exercises to be supported are arbitrary, yet require manual effort for a successful implementation.

There are thousands of different exercises employed by different therapeutic schools, thus automated extraction methods could provide a great benefit to this area. Furthermore, the reliable objective assessment of quality of motion, even when supervised by a therapist is a challenge, since inter-rater variance is notably high [3]. Thus, automated or human computation supported methods could be of great benefit in this area.

Based on the current state of the art, my research aims to establish a human computation based pipeline for extracting validated movements from instruction sheets. In order to generate a 3D animation from instructions, a number of different steps are required. As mentioned in Figure 1, the pipeline can be divided into three main steps. Each of these three steps is elementary to achieve the main goal, where text based instruction sheets are the source and adequate video-based animations are the output. The aim is to initially approach each of these three steps using human computation [4, 5]. A summary of the steps is listed below:

Step 1 – *Semantic Information*: In this step, we extract all required information to generate animation from textual instructions. The system mainly try to extract three different types of information using semantic information, i.e.:

- Actions – what type of action, e.g. lift, tilt etc.;
- Body part – which are involved with the exercise e.g. shoulders, legs etc.;
- Location – from where to where is the body part to be moved.

Step 2 – *Implicit Information* (Bayesian Network): If out of the three above-mentioned information one is missing, we use Bayesian Network. Hereby we extract all implicit information which is not possible to extract using semantic parser but easily understandable for the human brain.

Step 3 – *Animation creation*: This is the last step before we get our main goal. After extracting all required information from Step 1 and 2, the system automatically

Figure 1: Pipeline for Virtual Movement from Textual Instructions

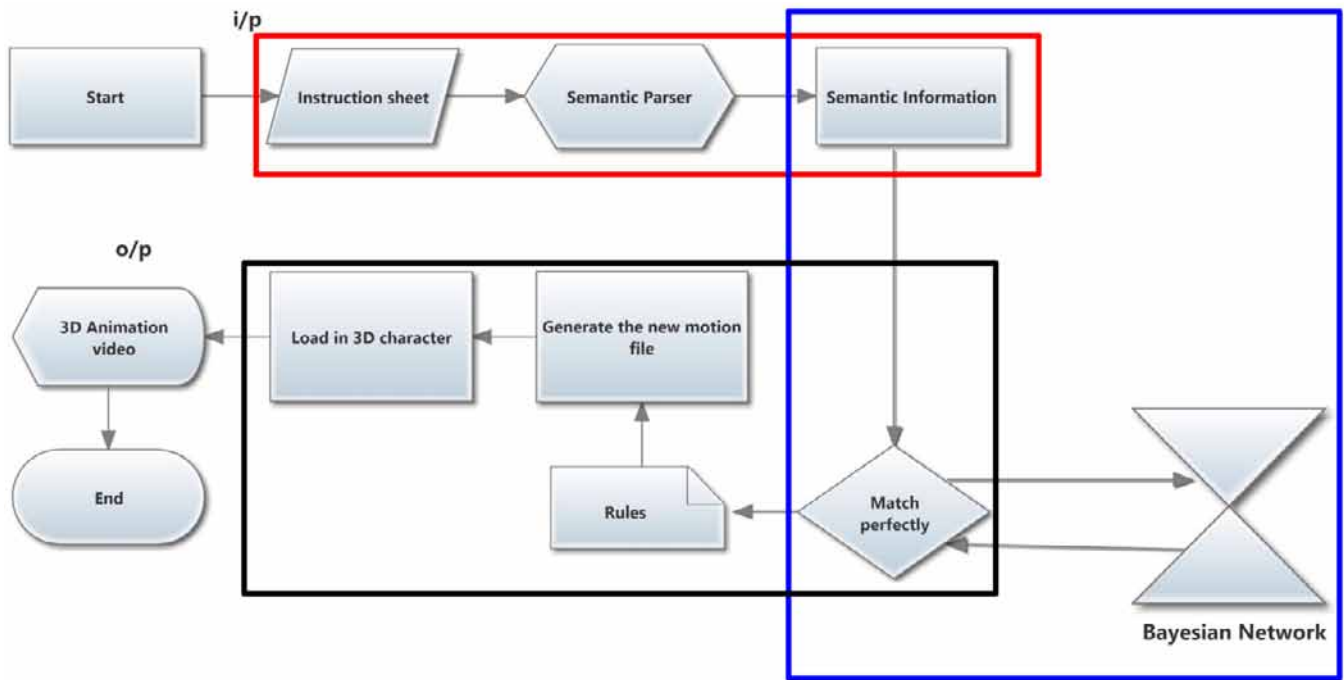

generates animation files with this information using behavior markup language and generate the animation video of the exercise.

After completing the three steps listed above, the motion files are loaded to control a 3D character to generate the 3D animation video which is the designated output.

References

- [1] Uzor, S., Baillie, L. (2014). Investigating the long-term use of exergames in the home with elderly fallers. *Proceedings of the SIGCHI Conference on Human Factors in Computing Systems ACM*, pp. 2813–2822.
- [2] Smeddinck, J.D., Herrlich, M., Malaka, R. (2015). Exergames for physiotherapy and rehabilitation: A medium-term situated study of motivational aspects and impact on functional reach. *Proceedings of the 33rd Annual ACM Conference on Human Factors in Computing Systems ACM*. pp. 4143–4146.
- [3] Pomeroy, V., Pramanik, A., Sykes, L., Richards, J., Hill, E. (2003). Agreement between physiotherapists on quality of movement rated via videotape. *Clinical rehabilitation*, 17(3), pp. 264–272.
- [4] Sarma, H., Porzel, R., Smeddinck, J. D., Malaka, R., and Samaddar, A. B. (2018). A Text to Animation System for Physical Exercises. *The Computer Journal*, 61(11), pp. 1589-1604.
- [5] Sarma, H., Porzel, R., Smeddnick, J. and Malaka, R. (2015). Towards generating virtual movement from textual instructions: a case study in quality assessment. *Proceedings of the third AAAI conference on human computation and crowdsourcing (HCOMP-2015)*.



Sarma Himangshu, B.E. M.Tech

Email: sarma@uni-bremen.de
 Country: India
 Start: 29.07.2014
 Supervisor: Prof. Dr. Rainer Malaka
 Faculty: Mathematics / Computer Science
 Research Group: Digital Media
 Funded by: Erasmus Mundus project cLINK

Monitoring External Supply Chain Risks in Apparel Sourcing through Text Mining

The Global Apparel Retail Industry is vastly dependent on the performance of garment suppliers located in the Asian countries with low-cost but a longer lead time of supply. Sourcing apparel products from the right supplier, at the right price and in the right country with minimum risks is a challenging task. Online newspapers describe the latest developments in a country and provide insightful of companies in a particular region with unprecedented speed. Text Mining like Data Mining has been recognized to be a prevailing approach for data analytics and trend predictions. It could find implicit and potentially useful patterns from a large historical text repository of a newspapers. We propose a text-based sentiment analysis approach to construct useful indicators for monitoring external risk in the apparel industry based on free and raw text.

Sayed Mehdi Shah*



Introduction >>> Apparel companies are facing steep competition in the global market and are working in global value-added chains. China is no longer the only option for textile and apparel sourcing, and it certainly is no longer the cheapest option. The high overseas outsourcing rate in garment manufacturing make it more dependent on the performance of the suppliers, supply chain, and the related external risks. The clothing and textile industry is a typical example of a global supply chain. It is difficult to predict the disruption associated with the supply chain because of the uncertainty and variability of risks [1]. Nevertheless, a proactive Supply Chain Risk Management is crucial due to the high number of the risk events and the limitation of the firefighting system. IT-based innovations have generated and captured more data while also changing the nature of the business. Data Mining extends beyond mere numerical analysis and Text Mining extends knowledge management to language data [2]. A growing number of organizations have started to use Business Intelligence and Data Mining approaches to make an efficient, intelligent, and timely decision. <<<

Key Drivers of Apparel Outsourcing

Outsourcing production offshore to low-cost regions to reduce cost is a common practice in the clothing industry. There are many factors influencing the export performance of apparel industry in developing countries, however, according to McKinsey Apparel Chief Purchasing Officers Survey 2017 [3] cost of raw materials, exchange

rates and labor cost, are the three major drivers of apparel sourcing in the years ahead. The associated risks are shown in Fig1.

Text Mining

Different techniques have been used to cater to different kind of risks. Structural equation modeling (SEM) was used to propose a partner selection and flow allocation

Figure 1: Key Drivers of Global Apparel Sourcing and Associated External Risks

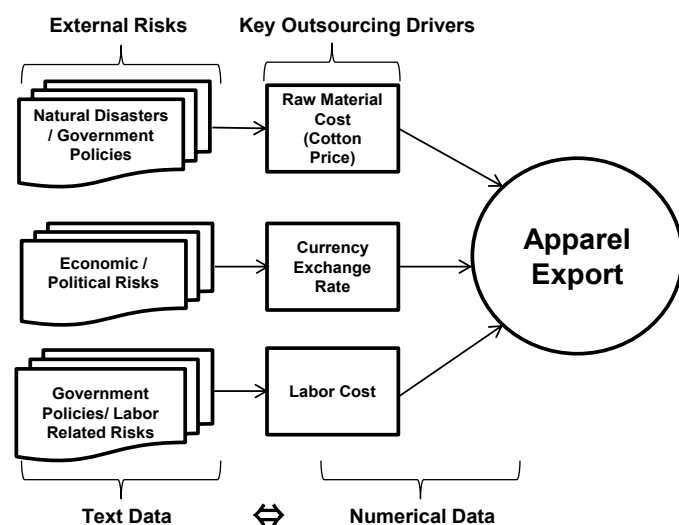

decision-making model based on a survey of the Indian apparel industry [4]. Similarly, Interpretive Structural Modeling (ISM) was used to approach effective supply chain risk mitigation in Indian manufacturing SMEs [5]. Fuzzy logic-based modeling for global outsourcing was also utilized for decision evaluations [6]. The drawback of ISM, SEM and Fuzzy logic-based approaches is that the obtained model may be influenced strongly by the bias of the person who is judging the variables.

To reduce this human intervention, big data and Text Mined-driven information in the supply chain can be collected, disseminated, and analyzed. In the apparel industry, data mining and text mining techniques have been used in fashion trend forecasting, sale forecasting, or in the textile industry for system improvement [7]. Text analytics were applied to mainland Chinese-language newspapers over the period from 2003 to 2017, and a monthly Chinese Labor Market Conditions Index (LMCI) was developed. This text analytics supported index not only extracted useful labor market information from Chinese newspapers articles, it also provided forecasts that were significantly superior compare to the official Chinese labor market indicators [8].

Research Approach

A systematic screening of online newspapers can reveal important insights. There is a research gap, to use the text mining analytics of online newspapers for external risk monitoring in the apparel industry. The research approach will be similar to the one of J. Li et al. (2017) used for the trend forecasting of oil prices based on the sentiment analysis of news. The different steps are briefly explained as follows:

Step 1 – *Data Preparation*: Natural Language Tool Kit (NLTK) is a leading platform for building Python programs to work with human language data. Data related to

three key variables are gathered separately from different online newspaper to build up a large data set. Duplicate records, filling up missing words, modifying incomplete records are removed. The raw data is then structured into the database with index and attributes, which unify the data format and prepare the input for application and data analysis.

Step 2 – *Sentiment Analysis*: The processed texts are further analyzed via Python library Textblob, with defined positive and negative words. Sentiment $\in [-1, +1]$ is the difference between the counts of positive and negative words divided by the sum of positive and negative word counts in the available news articles.

Step 3 – *Relationship Investigation*: Whether and how the sentiment impacts the three key drivers of the apparel industry will be determined by Granger Causality Analysis. Where time series X (Sentiment) Granger causes time series Y (Cotton Price, Labor Cost, or Currency Exchange). The patterns in X are approximately repeated in Y after some time lag. Thus, past values of X can be used for the prediction of future values of Y. Based on the Granger Causality Analysis, the impact of sentiment on Cotton Price, Labor Cost, or Currency Exchange can be statistically tested in terms of the p-value.

Step 4 – *Risk Trend Prediction*: Support-vector machine (SVM) is a recently popular AI technique. It performs as forecasting technique to investigate the predictive power of sentiment for the trends of the three mentioned indicators [9].

The aim of the research project is to identify early warning signals to forecast supply chain disruption in the global complex. The approach is restricted to external risks, particularly to Supply Chain Risks related to Apparel Industry.

References

- [1] Kumar, S., Himes, K. and Kritzer C. (2014). *Risk assessment and operational approaches to managing risk in global supply chains*, J. *Manuf. Technol. to Manag. risk Glob. supply Chain.*, 25(6), pp. 873–890
- [2] Mithas, S., Ramasubbu N. and Sambamurthy V. (2011). *How information management capability influences firm performance*, *MIS Q.*, 35(1), pp. 237–256.
- [3] Berg, A., Hedrich, S., Lange, T., Magnus, K. and Mathews, B. (2017). *The apparel sourcing caravan's next stop: Digitization*. (Publisher is missing or link or date of access)
- [4] Jakhar, S. K. (2015). *Performance evaluation and a flow allocation decision model for a sustainable supply chain of an apparel industry*. *J. Clean. Prod.*, 87(1), pp. 391–413.
- [5] Faisal, M. N., Banwet, D. K. and Shankar, R. (2011). *Supply chain risk mitigation: modeling the enablers*. *J. Adv. Manag. Res.*, 11, pp. 232–256.
- [6] Aksoy, A. and Öztürk, N. (2016). *Design of an intelligent decision support system for global outsourcing decisions in the apparel industry*. *J. Text. Inst.*, 107(10), pp. 1322–1335.
- [7] Fung, B. C. M., Liu, W. and Rahmana, O. (2014). *Using data mining to analyse fashion consumers' preferences from a cross-national perspective*. *Int. J. Fash. Des. Technol. Educ.*, 7(1), pp. 42–49.
- [8] Bailliu, J., Han, X., Kruger, M. and Liu, Y.H. (2018). *Can media and text analytics provide insights into labour market conditions in China? BOFIT Discussion Papers*. (Link and Date of access are missing)
- [9] Li, J., Tang, L. and Yu, L. (2017). *Forecasting Oil Price Trends with Sentiment of Online News Articles*. *Asia-Pacific J. Oper. Res.*, 34(2), p. 22.

*Co-Author

Ingrid Rügge



Sayed Mehdi Shah, MBA

Email: ssm@biba.uni-bremen.de
 Country: Pakistan
 Start: 01.08.2017
 Supervisor: Prof. Dr. Michael Freitag
 Faculty: Production Engineering
 Research Group: Planning and Control of Production Systems
 Funded by: HEC - DAAD

Human Activity Video to Virtual Reality Execution

Online videos are knowledge resources for a large variety of daily human activities to teach robotic agents. However, learning from 2D videos has limitations to understand the underlying physics such as pressure for grasping, acceleration, 3D motion patterns to analyze activity-specific motion pattern. We proposed a framework to interact with a physics enabled avatar, a human character from Unreal Engine. It provides the opportunities to transfer knowledge from real-world to the unreal world and assists to understand the relevant physics. We will present details of the 2D to 3D Deep Regression Network architecture, and show the simulated results for pick and place demo.

Feroz Ahmed Siddiky*



Introduction >>> Knowledge resources such as online videos demonstrating daily human activities could be excellent learning sources for robotics agents. To learn the manipulation tasks from these videos, it is an essential requirement to understand the activity-specific motion pattern. A deep understanding of motion pattern includes tracking the manipulation tasks, retrieve the 3D trajectories, and identify the physical laws behind that motion pattern while the 2D videos are limited to provide this information. We proposed a framework to overcome this limitation by using a 2D-to-3D pose estimator for 3D trajectories and export those trajectories to animate an avatar [6] in Unreal Engine (UE). The solution combines data-driven specifications of activities to execute similarly in the physical simulation. The proposed framework is constructed by three steps of data processing to convey real-world information from 2D videos into an avatar in the virtual world. The first step deals with 2D data processing, such as locating objects and estimate 2D poses. <<<

Object Detector and 2D Pose Estimator

For object detection, we use the novel detector YOLO proposed by Redmon et al. [1], [2]. YOLO uses the topmost feature map to predict confidences for multiple categories and bounding boxes from $S \times S$ grid of

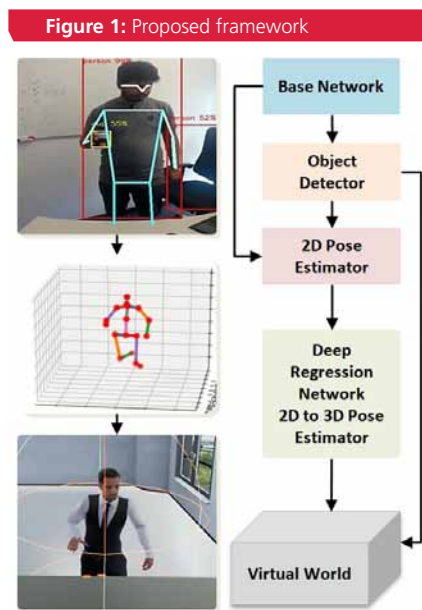

input image. SimplePose [3] proposed by Xiao et al. used for 2D pose estimation. The network has three steps of up-sampling and convolutional parameters into de-convolutional layers on top of the backbone network. It uses optical flow for multi-person poses tracking.

Deep Regression Network (DRN)

We proposed a novel regression network for 2D poses $J_{(x,y)}^{2D}$ to 3D pose $J_{(x,y,z)}^{3D}$ estimation where x and y are the coordinates and z is the depth of (x,y) points. The input

features are created from 2D poses while taking the angles θ from the arms and legs joints and the distance d with respect to the top head and spine joints. Thus we created single input vector of 45 dimensions $f_{input}^{2D}(J_i^{2D}, \theta_j, d_k)$ for the target pattern $f_{target}^{3D}(J_i^{2D}, Z_i)$. DRN has three sub-networks discussed in the following subsections.

Ensemble Networks: It is constructed with six independent classifiers using fully connected (FC) layers. Each classifier has two hidden layers with 100 and 400 neurons. We establish a connection from the second layer of all classifiers to the next convolution section. For this, we reshape the 400 neurons to a 2D vector and concatenate it from all classifier such as $20 \times 20 \times 6$. The ensemble approach gives three specific advantages: a) extends dimension from limited features, b) reaches better approximation due to different range weights initialization and c) expands the space, to get the possible best mapping from different classifiers.

Convolutional Networks: We introduced block-wise (three blocks) convolution layers to extract the important regression features hierarchically. Convolutional filters 1×1 are used to support the regressor property by setting weights with a higher standard deviation scaling coefficient and scaled exponential linear units [5] as active function. For feature extraction, a convolu-

Figure 2: 2D to 3D Deep Regression Network and Pick and Place Demo

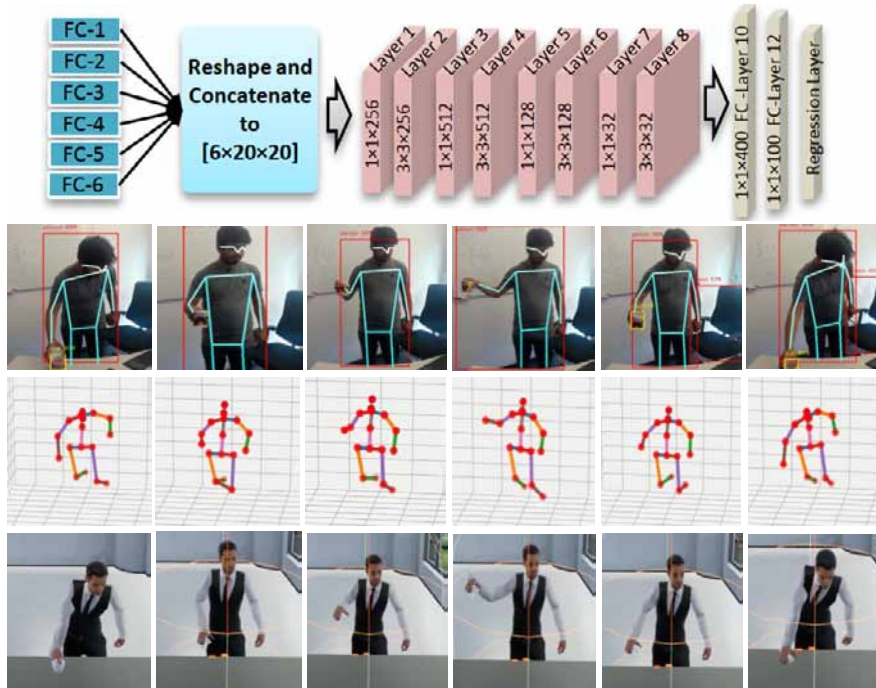

tional filters 3×3 set with softsign [4] as active function with lower values standard deviation for the weights initialization. Three blocks are arranged consecutively by 3, 3 and 2 layers (figure 2 first row) separated by max-pooling layers.

Regression Network: The regression section has three FC layers to get the regression output. From the last convolutional layer, features are flattened into a single dimension vector and feed as input for the FC layer. Finally, the regression loss is computed using the Smooth L1 [7] function.

Virtual Reality

The 3D poses and the objects' information are passed to the avatar from the Unreal Engine [6]. We created a special communication using the Transmission Control Protocol (TCP) to transfer data in real-time from the real-world to the unreal world.

In the simulation, the avatar is set up with all possible physics properties controlled by the programs. These features enable further experiments using reinforcement learning methods to learn robust control policies capable of imitating activities, learning complex recoveries, dynamic environment adaptation to accomplishing user-specified goals.

Result and Conclusion

The pick and place demo by the proposed framework and the corresponding 2D to 3D poses using DRN networks shown in Figure 2. It enables to execute more realistic manipulation in the virtual world and provides environmental variation for further physics experiments to learn the correct motion pattern from interactive settings that could be executable by the robotics controller.

References

- [1] Redmon, J. and Farhadi, A. (2018). Yolov3: An incremental improvement. ArXiv, 1804.02767
- [2] Redmon, J., Divvala, S., Girshick, R. and Farhadi, A. (2016). You Only Look Once: Unified, Real-Time Object Detection. IEEE Conference on Computer Vision and Pattern Recognition (CVPR), June 27-30, 2016
- [3] Xiao, B., Wu, H. and Wei, Y. (2018). Simple baselines for human pose estimation and tracking. Proceedings of the European Conference on Computer Vision (ECCV).
- [4] Turian, J., Bergstra, J. and Bengio, Y. (2009). Quadratic features and deep architectures for chunking. Human Language Technologies, pp. 245–248.
- [5] Nair, V. and Hinton, G. E. (2010). Rectified linear units improve restricted boltzmann machines. ICML, pp. 807–814, Haifa.
- [6] Haidu, A. and Beetz, M. (2019). Automated Models of Human Everyday Activity based on Game and Virtual Reality Technology. International Conference on Robotics and Automation (ICRA)
- [7] Girshick, R. (2015). Fast R-CNN. IEEE International Conference on Computer Vision (ICCV).

*Co-Author

Michael Beetz



Feroz Ahmed Siddiky, M.Sc.

Email: siddiky@cs.uni-bremen.de
 Country: Bangladesh
 Start: 01.04.2015
 Supervisor: Prof. Michael Beetz Ph.D.
 Faculty: Mathematics / Computer Science
 Research Group: Institute for Artificial Intelligence
 Funded by: DAAD - GSSP

Alternative Distribution Channels Provided by BRI

In 2013, China proposed to jointly establish the Belt and Road Initiative (BRI). This is a long-term development policy with a focus on transportation infrastructure construction and connectivity promotion. Under its framework, new railway and maritime links are planned, which offer alternative distribution channels to support cross-border transportation and logistics. This article reviews the content of the BRI to lay the foundation for future research.



Introduction >>> The BRI was proposed in 2013. However, the first official document “Vision and Actions on Jointly Building Silk Road Economic Belt and 21st Century Maritime Silk Road” that explains the strategy was published two years later. Until now, in terms of this initiative, no specific geographic boundary is given, nor the involved country list. Chinese authorities emphasize BRI is inclusive and open. To acquire some ideas about the BRI, to further discuss the possible pattern shifts of trans-Eurasian transportation, the focus of this work is on the emerging distribution channels. This article first presents a brief introduction of BRI by reviewing some critical official documents and websites. Then, the planned route map of CHINA RAILWAY (CR) Express and “three blue economic passages” are present. <<<

A brief introduction of BRI

Against the background of a slowdown in the domestic growth, China proposed to jointly establish the “Silk Road Economic Belt (SREB)” and the “21st Century Maritime Silk Road (MSR)” in 2013, also called the Belt and Road Initiative (BRI). This ambitious initiative intends to promote economic growth and regional development by improving traffic connectivity and cooperation between Asia, Africa, and Europe. The land-based SREB plans to establish roads, railways, and pipelines across central Asia to Europe, trying to connect three major routes spanning the Persian Gulf, the Mediterranean, and the Indian Ocean. Along the SERB, there are three directions: (1) through Central Asia and Russia to connect China

and Europe; (2) through Central Asia to connect China and the Middle East; (3) connect China and Southeast Asia, South Asia and the Indian Ocean areas. The MSR focusses on using Chinese coastal ports through two directions: (1) through the South China Sea and the Indian Ocean to connect China and Europe; (2) through the South China Sea to link China with the South Pacific Ocean.

In March 2015, the Chinese government released the first statement “Vision and Actions on Jointly Building Silk Road Economic Belt and 21st-Century Maritime Silk Road”, illustrates a grand blueprint as the strategic-level framework. It presents five major goals to enhance regional cooperation: policy coordination, facilities connectivity, unimpeded trade, financial integration, and people-to-people bonds. *Policy coordination* refers to China’s aspirations to formulate cooperation plans and measures with other countries to jointly provide policy support. *Facilities connectivity* refers to the intention to build critical transit corridors by infrastructure facilities construction. *Unimpeded trade* and *financial integration* refer to the efforts to remove constraints of cross-border trade and investment, to encourage monetary coordination (for instance, internationalization of Chinese currency), to build practical mechanisms for financial risk management, etc. *People-to-people* bonds refer to cultural exchanges between countries, to diminish differences in culture and support the mobility of people. In the same year, the Chinese government set up the Office of the Leading Group for the BRI. Meanwhile, to support

the establishment, China established the Silk Road Fund and the Asian Infrastructure Investment Bank (AIIB) to provide better financial resources.

There are a lot of other official documents that explain policies, regulations, bilateral agreements, and local planning. Among all these documents, there are two requiring special attention; one is the “Development Plan of China-Europe Freight Train Construction (2016-20)” the other is the “Vision for Maritime Cooperation under the Belt and Road Initiative.” The former reveals the top-level planning of the CHINA RAILWAY (CR) Express; the latter is the first document released the plan to establish three “blue economic passages.”

China Railway Express

Based on the analysis of the background and the demand for railway freight between China and Europe, this official document presents the spatial structure design of the railway transit corridors, hub nodes, and routes. Operated by the state-owned enterprise China Railway Corporation, CHINA RAILWAY (CR) Express is to offer international container freight transportation services between China and Europe. According to “Development Plan of China-Europe Freight Train Construction (2016-20)”, there are three planned directions of transportation routes, as shown in Figure 1. The pattern of train organization is designed as “main lines combined with branch lines, hub distribution,” and 43 hubs are set up which respectively located at main inland sources of goods, main railway hubs, main seaports, land border ports.

Figure 1: Planned route map of CHINA RAILWAY Express



Figure 2: Three “blue economic passages”

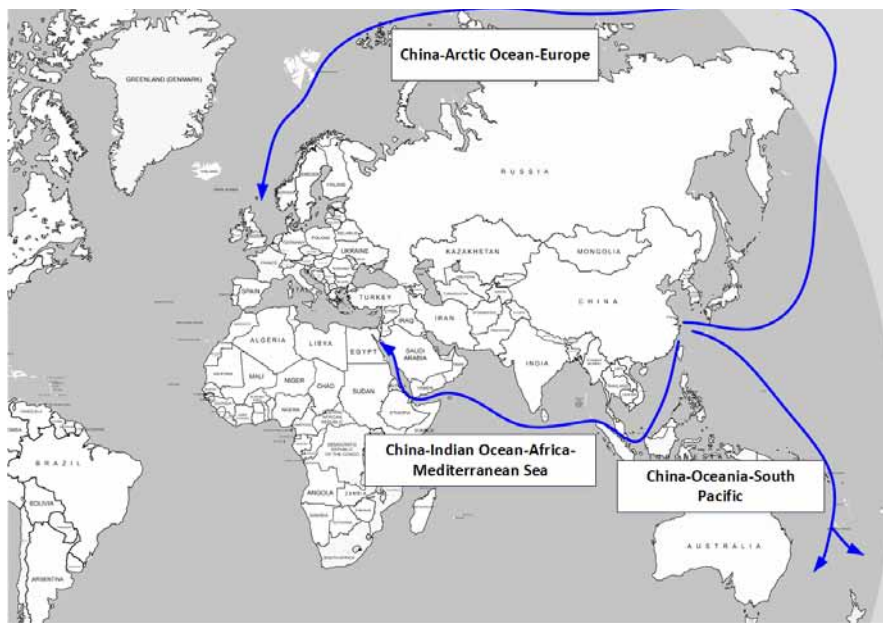

constructing maritime corridors. Chinese authorities intend to build the mutually-beneficial “blue partnership” with involved countries, and emphasized green development, ocean-based prosperity, maritime security, innovative growth, and collaborative governance. In this vision plan, three “blue economic passages” were proposed in line with the strategic priorities of the MSR, as shown in Figure 2:

The *China-Indian Ocean-Africa-Mediterranean Sea passage* intends to link the China-Indochina Peninsula Economic Corridor, running westward from the South China Sea to the Indian Ocean, and connecting the China-Pakistan Economic Corridor and the Bangladesh-China-India-Myanmar Economic Corridor. The *China-Oceania-South Pacific route* runs from the South China Sea to the Pacific Ocean. The *China-Arctic Ocean-Europe* is envisioned extending to Europe via the Arctic Ocean.

Discussion

The improved facilities connectivity may have significant impacts on the pattern of transportation and logistics on a regional scale. Volume and transportation mode shifts may take place due to the available services offered by CR Express, and the relative significances of some seaports may change since BRI improved port infrastructure in specific locations.

***Co-Author**

Hans-Dietrich Haasis

The western routes have three main branches; one runs through Kazakhstan connecting to the TSR; one crosses the border at Horgos Border port (Xinjiang); one runs across Torugart pass (Irkeshdam) and connects to the planned China-Kyrgyzstan-Uzbekistan Railway. The central route runs across Erlianhot land port and through Mongolia to connect to the TSR.

The Eastern route goes across Manzhouli land port linking to the TSR. All these passages end in European destinations.

China’s MSR vision

“Vision for Maritime Cooperation under the Belt and Road Initiative” published in 2017 reveals the principles, framework, cooperation priorities, and China’s action for



Ye Jing, M.Sc.

Email: jye@uni-bremen.de
 Country: China
 Start: 01.10.2016
 Supervisor: Prof. Dr. h.c. Hans-Dietrich Haasis
 Faculty: Business Studies / Economics
 Research Group: Business Administration, Maritime Business and Logistics
 Funded by: China Scholarship Council (CSC)

A Shoe for Surgeons to Interact with Radiological Images

During surgeries, surgeons often need to review radiological images. Usually, surgeons need to rely on an assistant to browse the images because of sterility requirements. Communication with a substitute operator is tedious and error-prone if the operator does not have an equal level of professional experience. To overcome the barrier of dependency, we present a sensor-integrated shoe allowing surgeons to interact radiological images by own foot movement. The performance of the shoe interface has been evaluated against a control condition with assistant together with ten surgeons in an empirical user study. Our results provide the effectiveness of a shoe interface in this application area.

Ambreen Zaman*



Introduction >>> Digital data is the key to successful diagnosis and intervention planning. However, there exists an interaction gap when looking at input devices for pre-operative planning compared to the possibilities for intra-operative interaction [1]. During surgeries, surgeons often need to go through a radiological image. Surgeons usually need to rely on an assistant to browse the images because of sterility requirements.

To overcome the barrier of dependency, it would better to provide the surgeon with a comfortable, precise, and sterile input device to interact with radiological images. This paper presents a foot-based interaction device, an interactive-shoe, which can be operated by surgeons to manipulate medical image data in a hygienic way. The main advantages of using foot based systems are that the surgeons have direct control over many parameters of the surgical instruments, while their hands are free for the main surgical procedure. <<<

Related Work

Using the feet for human-computer interaction (HCI) is well established in many areas, e.g., for driving vehicles or digital music controls. In HCI, foot interaction is still largely unexplored, even though it has been proposed already in the early days of HCI [2,3]. Few researchers [4] have investigated suitable real-world mappings of foot

gestures to invoke mobile device commands. Foot interfaces have also been used for pedestrian navigation [5]. Another sensor-integrated shoe is used to capture expressive degree of freedom for computer-augmented dance performances [6]. Some mediated sensing commercial products such as large trackballs [7], the Nintendo Wii Balance Board [8], or the BiliPro Foot-time Foot-Mouse [9] have been developed, but none are suitable to be employed in the Operating Room (OR). A different device, the so-called Shoe-Mouse, was designed foremost as a platform to collect data from foot movement [10] but a similar setup could also be tested in the context of surgery. Díaz et al. [11] developed a foot pedal that provides real-time feedback through the foot, for example, tactile warning cues to support the surgeon during robotic surgery. Hatcher et al. [12] also proposed foot input concepts with one degree of freedom and found that relative input performed significantly better than absolute or rate-based input. Rohit et al. [13] designed an approach by involving the foot to reduce the workload on the hand. This approach distributes the total interaction load and improves work efficiency. Velloso et al. [14] provided a survey and general characterization of foot-based interaction. They investigated the interaction possibilities of the lower limbs and found that foot-interfaces complement and assist the hands rather

than replacing them. Additionally, they explored the possibilities of reassigning pointing devices from the hands to the feet and found that the mouse consistently performs better than other foot-based interfaces.

Interaction Design and Concept

Our goal was to design an interactive device that is self-controllable, less complex, comfortable as well as precise and by which surgeons can easily access the desired 2D image data, e.g., MRI or CT scans, during an operation. For this, the pose of the user (sitting, walking, and standing), the available input senses of the lower limbs (intrinsic, extrinsic, and mediated), and the degrees of freedom of movement of the three joints of the lower limbs (the ankle, the knee, and the hip) needed to be considered during the design phase [14]. Moreover, surgeons also suggested to incorporate functionality similar to the scroll-wheel of computer mice to interact with 2D CT images.

With these design considerations in mind, we introduce an interactive shoe, a prototype of a shoe-based mouse based on the optical sensor system of an off-the-shelf computer mouse. We use the free scripting tool AutoHotkey to map the shoe-mouse input to control commands for a medical image viewer. We used foam rubber to manufacture a special shoe sole

Figure 1: The inside of the shoe sole



Figure 2: The interactive shoe



Figure 3: A dummy box



to properly integrate the sensor in a safe and reliable way.

The sole was shaped with a laser cutter, which allows for computer-aided construction and customization of the prototypes. Figure 1 shows the shoe sole and Figure 2 shows the complete interactive shoe. To protect the device from the bend of the toes and the pressure of the heel, we integrated the wireless computer mouse in the middle of the shoe sole. Additionally, we embedded a micro switch on the side of the sole to toggle the three states of the mouse: „left- click“, „scrolling“, „freeze“. Considering statistics about the average size of a shoe of the German population (male and female), we constructed prototypes for the European/German shoe sizes 39, 42, 44, and 46. Using an off-the-shelf surgical sandal, the sensor-integrated shoe sole is attached with a strong velcro-tape, which allows to safely attach and remove the sole.

Experiment Design and Methodology

A use case-study was carried out to evaluate the performance of the interactive shoe. The focus of this study was to provide a proof-of-concept and investigate the principle feasibility of the approach.

The study design was inspired by clinical workflows and focused on the elemental task of browsing medical image data, which is relevant to clinical settings. We were interested in how well users could manipulate the visual representation while trying to reach a certain view on the data, and we wanted to compare the required effort within the limited acclimatization time.

Again, the experimental design was motivated by the surgeons' need for independent and efficient interaction with medical image data during interventions. Therefore, we designed a task that required users to select a 2D image (slice) from a CT scan data set using the aforementioned custom-build visualization software (a basic medical image viewer) and the interactive shoe.

To provide a repeatable and well-defined task and to generate a well-controlled CT data set and limit potential biases due to the different experience levels of participants, we designed and scanned a dummy box made of Styrofoam containing balls of different colors and materials, i.e., fluffy balls, wooden balls, and Styrofoam balls. During the case study, this dummy box was placed on the tabletop, and its surroundings were covered with a piece of green cloth,

as shown in Figure 3. The task of the users was to remove the small ball, which was hidden beneath one of the big balls by using the information of the CT scan data of the dummy box presented on a screen. The study included two conditions that only differed in the way the CT data could be browsed: (Method 1) Using the interactive shoe and (Method 2) relying on an assistant to browse through the slices (Assistant Controlled Computer Keyboard; ACCK). The participants performed three repetitions for each condition using three different setups of the dummy box. The concept behind this experimental task design is that surgeons mostly look for specific orientations and they try to match the orientation of the 2D image data as closely as possible to a desirable target orientation, e.g., matching the current orientation of the patient as closely as possible to help them to acquire an accurate mental model of the current situation to proceed with the intervention.

The study was conducted with ten surgeons (9 male, 1 female; mean age 44.5 years) of two hospitals in Germany. Surgeons had between 5 and 30 years of experience. The participants had no known disorders. With the exception of one surgeon, they had no prior experience with foot-based interfaces. While they were informed about the general procedure and task at the introduction (informed consent), they did not know the specific hypothesis underlying the experiment. All participants were right-footed as no left-footed participants volunteered for the study. Each participant signed a consent form and demographic information before the start of the experiment. As mentioned above, they had to perform the same tasks under two different conditions (within-subjects design). The order of conditions was pseudo-randomized by alternating the starting condition across participants and the three tasks were presented in random order for each condition.

Figure 4: The likert-scale post task questionnaire

• I think this system.....

- is fun to use:
- is comfortable to use:
- provides high accuracy:
- is accessible:
- causes thigh fatigue:
- causes calf fatigue:
- causes foot fatigue:

Strongly Agree					Strongly Disagree
1	2	3	4	5	
1	2	3	4	5	
1	2	3	4	5	
1	2	3	4	5	
1	2	3	4	5	
1	2	3	4	5	
1	2	3	4	5	

The participants were allowed to have a short training period before starting each condition so they could familiarize themselves with the devices and the environment. Images were presented on a 32" monitor placed on an otherwise empty desk. A Lenovo Thinkpad T410 laptop was used to record user task completion times, activate the interactive shoe functionality, and run the visualization software. A video camera and a webcam were used for recording user performance. The video camera captured facial expression and the webcam captured foot movements. The whole task performance was also recorded using the free screen capture video software Ice Cream Screen Recorder.

To measure general usability, we recorded task completion times and collected subjective feedback after each condition with the System Usability Scale (SUS) [15] and additional custom Likert-scale questions presented in Figure 4.

Results and Discussion

The results of the average task completion times are presented in Tables 1 and 2, which indicate that both methods achieved comparable completion times during our experiment.

Table 1: Interactive shoe

Task Completion Time	
CT scan 1	65.74
CT scan 2	41.5
CT scan 3	45.75
Mean	51.01

Table 2: ACCK

Task Completion Time	
CT scan 4	61.1
CT scan 5	41.2
CT scan 6	48.85
Mean	51.01

The SUS questionnaire outcomes are presented in Figure 5. The interactive shoe has scored 59.75 points on average and the ACCK average score is 64 points, i.e., in absolute scores the control condition

Figure 5: Mean± SE SUS scores

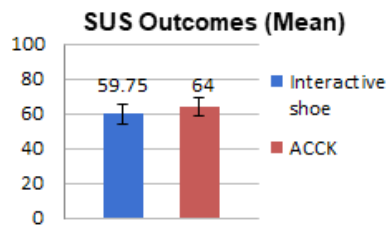

achieve a slightly higher usability rating by the participants in our experiment than the interactive shoe.

In terms of qualitative feedback, surgeons remarked that the proposed device is independent, easy to handle, and quite comfortable to operate. This is in-line with the results of the post-task questionnaire presented in Figure 6.

Figure 6: Results of the post task questionnaire (Mean± SE)

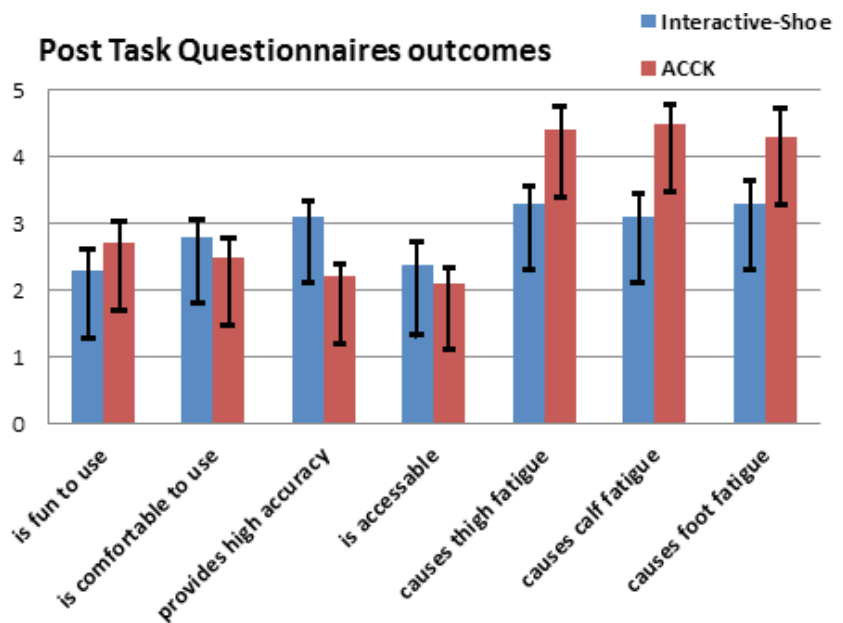

They also stated that they would expect it to be more convenient during an actual operation because of being able to review the CT scan data more often. However, the participating surgeons also felt that scrolling using the prototype was too fast and hard to control. A paired t-test has been used to test for significant differences between the two groups. The result of the t-test for SUS (F1,9, p < 0.62) revealed no significant difference as both conditions achieved comparable usability ratings. The participants specifically appreciated the micro-switch outside the sole, which was also used to toggle activation to avoid accidental, unintended inputs.

Conclusion and Future Work

We presented a foot-based input device for intra-operative interaction with 2D image data while the surgeons' hands are occupied. We conducted a user study with surgeons taking qualitative and quantitative measures for general usability. However, as the prototype is still in an early stage, our results provide only a first indication of the potential of foot-based interaction in the OR. In addition to general improvements of the prototype, e.g., smoother tracking and options to personalize the mappings and sensitivity of controls, we are working towards evaluating the device in a real-world setting inside the OR.

References

- [1] Malaka, R., Dylla, F., Freksa, C., Barkowsky, T., Herrlich, M. and Kikinis, R. (2017). Intelligent Support for Surgeons in the Operating Room. In *Anticipation and Medicine*. Springer International Publishing, pp. 269–277.
- [2] Engelbart, D. (1984). Doug Engelbart Discusses Mouse Alternatives. Retrieved on March 3, 2014 from ftp://ftp.cs.utk.edu/pub/shuford/terminal/engelbart_mouse_alternatives.html
- [3] English, W.K., Engelbart, D. C. and Berman, M. L. (1967). Display-selection techniques for text Manipulation. *Human factors in electronics, IEEE Transactions, HFE-8(1)*, pp. 5–15.
- [4] Alexander, J. et al. (2012). Putting your best foot forward: investigating real-world mappings for foot-based gestures. *Proceedings of the SIGCHI Conference on Human Factors in Computing Systems, ACM*, pp. 1229–1238, doi:10.1145/2207676.2208575
- [5] Frey, M. (2007). CabBoots: shoes with integrated guidance system. *Proceedings of the 1st international conference on Tangible and embedded interaction, ACM*, pp. 245–246, doi:10.1145/1226969.1227019
- [6] Paradiso, J. A. and Hu, E. (1997). Expressive footwear for computer-augmented dance performance. *Digest of Papers. First International Symposium on Wearable Computers, IEEE*, pp. 165–166, doi: 10.1109/ISWC.1997.629936
- [7] Pakkanen, T. and Raisamo R. (2004). Appropriateness of foot interaction for non-accurate spatial tasks. *CHI'04 extended abstracts on Human factors in computing systems, ACM*, pp. 1123–1126, doi:10.1145/985921.986004
- [8] Schöning, J. et al. (2009). Using hands and feet to navigate and manipulate spatial data. *CHI'09 Extended Abstracts on Human Factors in Computing Systems, ACM*, pp. 4663–4668 doi:10.1145/1520340.1520717
- [9] URL BiLiPro. www.bilipro.com/ seen on June 12, 2019
- [10] Ye, W., Xu, Y. and Lee, K.K. (2005). Shoe-Mouse: An integrated intelligent shoe. *IEEE/RSJ International Conference on Intelligent Robots and Systems, IEEE*, pp. 1163–1167, doi: 10.1109/IROS.2005.1545262
- [11] Díaz, I., Jorge J. G. and Marcos L. (2014). A haptic pedal for surgery assistance. *Computer methods and programs in biomedicine*, 116(2), pp. 97–104.
- [12] Hatscher, B., Luz, M. and Hansen, C. (2018). Foot interaction concepts to support radiological interventions. *i-com*, 17(1), pp. 3–13.
- [13] Gupta, R. and Girish, D. (2018). FAND: A shareable gesture based foot interface device. *IEEE 6th International Conference on Serious Games and Applications for Health (SeGAH)*, pp. 1–7, doi: 10.1109/SeGAH.2018.8401321
- [14] Velloso, E. et al. (2015). The feet in human-computer interaction: A survey of foot-based interaction. *ACM Computing Surveys (CSUR)*, 48(2), 21, doi:10.1145/2816455
- [15] Bangor, A., Philip T. K. and Miller. J. T. (2008). An empirical evaluation of the system usability scale. *Intl. Journal of Human-Computer Interaction*, 24(6), pp. 574–594.

*Co-Author

Rainer Malaka



Ambreen Zaman, MIT

Email: ambreen@uni-bremen.de
Country: Bangladesh
Start: 27.12.2015
Supervisor: Prof. Dr. Rainer Malaka
Faculty: Mathematics / Computer Science
Research Group: Digital Media
Funded by: ERASMUS MUNDUS project FUSION

Combining Predictive Control with Integer Operators for Capacity Adjustment via RMTs

To cope with frequent demand fluctuations, capacity adjustment is one measure to balance capacity and load and improve the effectiveness of manufacturing control. We consider machinery-based capacity adjustment via reconfigurable machine tools. To include these tools effectively on the operational layer, we propose a complementing feedback approach using model predictive control associated with integer operators to identify the potential of RMTs for a better compliance with logistics objectives and a sustainable demand oriented capacity allocation. Utilizing simulation, we demonstrate the effectiveness of the proposed method for a four-workstation job shop system.



Introduction >>> Relying on high flexibility, job-shop production systems still retain their importance. Yet, this kind of system suffers from high work in process (WIP) with resulting bottlenecks which leads to long lead times and low reliability of due dates. Capacity adjustment as one measure is generally achieved by labor-oriented methods (e.g., overtime), which are already established in practice. Yet, the respective cost is relatively high and therefore not a sustainable solution in a long-term consideration. As an additional degree of freedom of capacity control, reconfigurability as a key enabler for handling exceptions and performance deteriorations in manufacturing operations have been developed and accomplished via reconfigurable machine tools (RMTs) [1]. To include these tools effectively on the operational layer, we combine model predictive control (MPC) with integer operators to exploit the potential of RMTs concerning flexible capacity adjustment to maintain WIP for each workstation in case of bottleneck. <<<

Problem Definition

Since WIP is an essential variable in manufacturing control [2], we follow the method proposed in [3] and control WIP directly. Consider a job shop system in form of discrete time which is expressed via:

$$x(n+1) = f(x(n), u(n), d(n)) \quad (1)$$

Here, $f: \mathbb{R}_{\geq 0}^p \times \mathbb{N}^p \times \mathbb{R}^p \rightarrow \mathbb{R}_{\geq 0}^p$ denotes the dynamics of the job shop system where $x := (x_1, \dots, x_j, \dots, x_p) \in \mathbb{X} \subset X \subset \mathbb{R}_{\geq 0}^p$ represents the WIP level of all workstations for time instant $n \in \mathbb{N}_0$, $u := (u_1, \dots, u_j, \dots, u_p) \in \mathbb{U} \subset U \subset \mathbb{N}_0^p$ denotes the vector of RMTs assigned to all workstations, and

$d := (i_{01}, \dots, i_{0j}, \dots, i_{0p}) \in \mathbb{R}_{\geq 0}^p$ represents the order input rates to the workstations, i.e. the input rates are not a degree of freedom but set externally. To incorporate possible constraints on the WIP level, we utilize the set notation $x \in \mathbb{X}$.

Moreover, the total number of RMTs in the system is fixed inducing the constraint $\sum_{j=1}^p u_j(n) \leq m \in \mathbb{N}_0$. Similar to the state set \mathbb{X} , we introduce the set \mathbb{U} to incorporate possible control constraints. Then, we call a state feasible if $x \in \mathbb{X}$ and an input $u \in \mathbb{U}$ admissible if $f(x, u, d) \in \mathbb{X}$ holds. Here, we assume the transportation time is neglectable. Note that the input variable u is uncertain which refers to reconfiguration delay. For more details about modelling including reconfiguration rule, see [4].

Solution Approach

In order to effectively control WIP while considering the impact caused by reconfiguration delays, we employ MPC algorithm which allows us to incorporate the system dynamics, constraints and performance index in a unified manner. Although the

method is demanding from both a computational and modeling point of view, it is widely applied in various industries [5], [6] and is readily to be applied in job shop systems associated with usage of RMTs [7]. The principle of MPC algorithm is given in Figure 1.

Figure 1: Principle of model predictive control

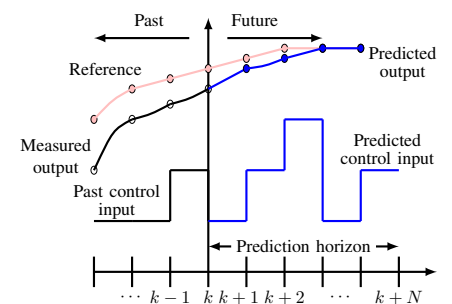

Its procedure includes three steps: in a first step, the current state of the system is obtained. Thereafter, a truncated optimal problem

$$\min J_N(x_0, u) = \sum_{k=0}^{N-1} \ell(x(k), u(k)) \quad (2)$$

$$\text{s.t. } x(k+1) = f(x(k), u(k), d(k)), x(0) = x_0 \\ x(k) \in \mathbb{X}, u(k) \in \mathbb{U} \forall k \in \{0, \dots, N-1\}$$

with a finite prediction horizon N is solved to obtain a corresponding optimal control sequence. In the last step, only the first element of this derived control sequence

is applied, rendering the procedure to be iteratively applicable. Combined, we obtain the modified MPC method outlined in Algorithm 1.

Algorithm 1 Basic model predictive control method

Require: $N \in \mathbb{N}$
 1: **for** $n = 0, \dots$ **do**
 2: Measure current state \hat{x} and set $x_0 := \hat{x}$
 3: Solve problem (2) to obtain optimal control $u^*(\cdot)$ sequence
 4: Apply $\kappa_N(\hat{x}) = u^*(0)$ to workstation
 5: **end for**
Ensure: Static state feedback κ_N

While the Algorithm 1 is correct from a control point of view, we still need to ensure that the number of RMTs in each workstation is a positive integer and the sum of numbers of RMTs in the system is limited and fixed. Since most MPC solvers are implemented using continuous optimization routines such as Sequential Quadratic Programming or Interior Point Methods, problem (2) is a integer optimization problem, typically a NP-hard. To this end, we propose to combine model predictive control with integer operators via floor operator, branch and bound (B&B) and genetic algorithm (GA) to resolve the integer assignment of RMTs. Given the system setting via [4], the comparison results together with PID with floor operator are presented in Figure 2, which shows that MPC in conjunction with B&B or GA are almost identical and both outperform other integer control strategies.

Conclusion

To achieve a high quality of shop floor control in the increasing turbulent industrial manufacturing environment, the potential of RMTs is exploited, which allow to improve competitiveness and responsiveness in the presence of demand fluctuations relying on its changeable capacity and functionality. We combined model predictive control with different strategies to address the integer assignment of RMTs for a sus-

Figure 2: Comparison of WIP level in each workstation by different methods

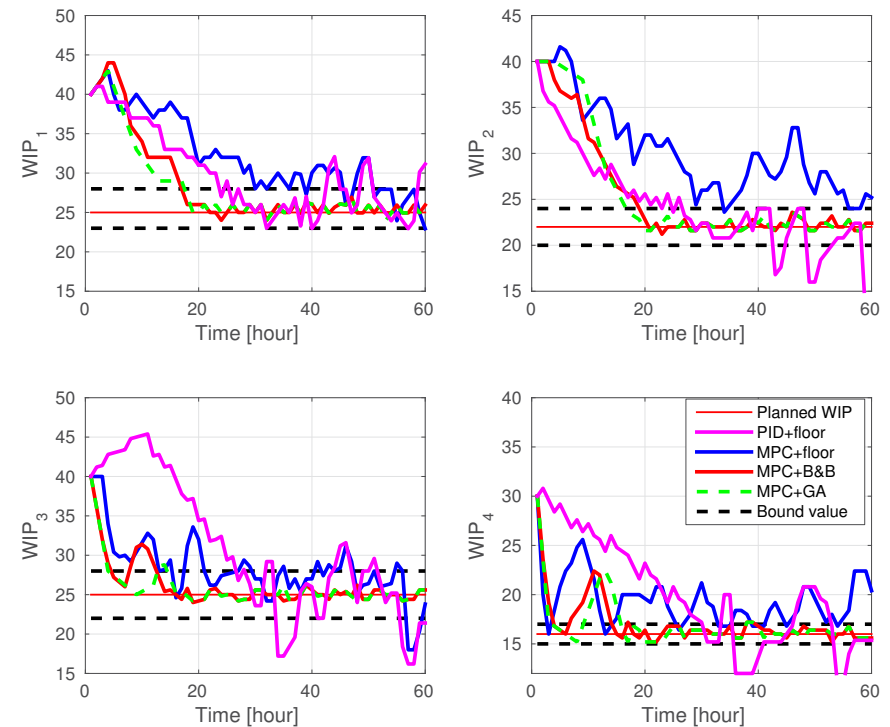

tainable capacity allocation. Through a case study, we showed applicability and effectiveness of our approach with the practically asymptotically stabilizing WIP.

References

[1] Landers, R.G., Min, B.K. and Koren, Y. (2001). Reconfigurable machine tools. *CIRP Annals-Manufacturing Technology*, 50(1), pp. 269–274.
 [2] Lodding, H. (2012). *Handbook of Manufacturing Control: Fundamentals, Description, Configuration*. Springer Science & Business Media.
 [3] Kim, J.-H. and Duffie, N. (2005). Design and analysis of closed-loop capacity control for a multi-workstation production system. *CIRP Annals-Manufacturing Technology*, 54(1), pp. 455–458.
 [4] Zhang, Q., Liu, P. and Pannek, J. (2019). Combining mpc and integer operators for capacity adjustment in job-shop systems with RMTs. *International Journal of Production Research*, 57(8), pp. 2498–2513.
 [5] Qin, S.J. and Badgwell, T.A. (2003). A Survey of Industrial Model Predictive Control Technology. *Control Engineering Practice*, 11(7), pp. 733–764.
 [6] Grune, L. and Pannek, J. (2017). *Nonlinear Model Predictive Control: Theory and Algorithms*. Springer.
 [7] Scholz-Reiter, B., Lappe, D. and Grundstein, S. (2015). Capacity Adjustment Based on Reconfigurable Machine Tools - Harmonising Throughput Time in Job-Shop Manufacturing. *CIRP Annals - Manufacturing Technology*, 64(1), pp. 403–406.

***Co-Authors**

Jürgen Pannek
 Ping Liu



Qiang Zhang, M.Sc.

Email: zha@biba.uni-bremen.de
 Country: China
 Start: 07.09.2015
 Supervisor: Prof. Dr. Jürgen Pannek
 Faculty: Production Engineering
 Research Group: Dynamics in Logistics
 Funded by: Erasmus Mundus project gLINK and LogDynamics

Reference to Previous Publications

The article on page 21 is an excerpt from: Bernardo, M. and Pannek, J. (2018). Robust Solution Approach for the Dynamic and Stochastic Vehicle Routing Problem. *Journal of Advanced Transportation*. DOI: <https://doi.org/10.1155/2018/9848104>

The article on page 31 is an excerpt from: Grudpan, S., Baalsrud Hauge, J. and Thoben, K. D. (2018). Challenges with tools and technologies supporting collaboration among stakeholders in urban logistics. *Proceedings of the 23th International Symposium on Logistics, ISL*, pp. 404-410.

The article on page 33 is an excerpt from: He, Z. and Haasis, H. D. (2019). Integration of Urban Freight Innovations: Sustainable Inner-Urban Intermodal Transportation in the Retail/Postal Industry. *Sustainability*, 11(6), p.1749. DOI: <https://doi.org/10.3390/su11061749>

The article on page 39 is an excerpt from: Intayoad, W. and Becker, T. (2018). Exploring the Relationship between Business Processes and Contextual Information in Manufacturing and Logistics Based on Event Logs. *Procedia CIRP*, 72, pp. 557-562. DOI: <https://doi.org/10.1016/j.procir.2018.03.220>

The article on page 47 is an excerpt from: Kuppusamy, V. (2018). Performance Analysis of Epidemic Routing in Destination-Less OppNets. 19th International Symposium on "A World of Wireless, Mobile and Multimedia Networks" (WoWMoM), IEEE. DOI: <https://10.1109/WoWMoM.2018.8449802>

The article on page 49 is an excerpt from: Liu, P. and Pannek, J. (2018). Operator-based capacity control of job shop manufacturing systems with RMTs. *Proceedings of the 6th International Conference on Dynamics in Logistics*, pp.264-272. DOI: https://doi.org/10.1007/978-3-319-74225-0_36

The article on page 59 is an excerpt from: Ye, J. and Haasis, H. D. (2019). Overview of Belt and Road Initiative (BRI) and Global Logistics Networks, presented on the International Association of Maritime Economists (IAME) in Athens, Greece. June 25-28, 2019.

The article on page 61 is an excerpt from: Zaman, A., Reisig, L., Reinschluessel, A. V., Bektas, H., Weyhe, D., Herrlich, M., Döring, T. and Malaka, R. (2018). An interactive-shoe for surgeons: Hand-free interaction with medical 2d data. *Extended Abstracts of the CHI Conference on Human Factors in Computing Systems, ACM*, p. LBW633.

The article on page 65 is an excerpt from: Zhang, Q., Liu, P. and Pannek, J. (2019). Combining MPC and Integer Operators for Capacity Adjustment in Job Shop Systems with RMTs. *International Journal of Production Research*, 57 (8), pp. 2498-2513.

Picture Credits

LogDynamics, BIBA
Title page: Bodo Nussdorfer
Page 2: Claas Beckmann
Page 3: Tine Casper
Page 8: Janine Lancker
Page 8: Iwen Schlichting
Page 10: Wolfgang Scheer / bremenports
Page 12: Janine Lancker, Dr. Saß, SWAH Bremen
Page 13: Hr. Platz, Hr. Herrmann, Hr. Völkl
Page 18: Chiang Mai University

Imprint

LogDynamics Research Report

ISSN 1867-0210

Volume 6, 2019

Research Report 2018/19

International Graduate School for Dynamics in Logistics +
Bremer Logistik Transfer- und Innovationskultur

Statutory Declaration

All rights reserved. No part of this publication may be reproduced, stored in a retrieval system, or transmitted in any form or by any means, mechanical, electronic, photocopying, recording, or otherwise, without prior written permission of LogDynamics.

Place of Publication

Bremen, Germany

Publisher

Bremen Research Cluster for Dynamics in Logistics (LogDynamics)
Universität Bremen

Responsible

Prof. Dr. Dr. h.c. Hans-Dietrich Haasis (IGS)

Prof. Dr.-Ing. habil. Klaus-Dieter Thoben (LogDynamics)

The sole responsibility for the content of the named articles lies with the authors.

Editor

Dr.-Ing. Ingrid Rügge

Contact

IGS, Universität Bremen

Hochschulring 20

28359 Bremen, Germany

Phone: +49 421 218 50139

Fax: +49 421 218 50031

Email: info@IGS.LogDynamics.de

Internet: www.LogDynamics.de

Design

Ricardo Andres Baquero, Dayana Markhabayeva, Ingrid Rügge

Line Editors

Ilknur Keskin, Carolin Neumann

Bremen Research Cluster for Dynamics in Logistics

Universität Bremen
Postfach 330 440
28334 Bremen, Germany

Email: info@LogDynamics.de
info@BreLogIK.de

Internet: www.LogDynamics.de
www.BreLogIK.de

ISSN 1867-0210